



中国建博会 (广州)
CBD Fair (Guangzhou)

全球链接
CBD World-Connect

SOURCING GUIDE

CBD Guangzhou
2025 **7/8-11**
CANTON FAIR COMPLEX



www.cbdfair-gz.com



@ CBD Guangzhou



CONTENTS

目录

01

关于中国建博会(广州) P01

About
CBD Guangzhou

02

展区分布图 P03

Exhibition Hall Layout
/ Floor Plan

03

亮点活动日程 P05

Highlight Events
& Schedule

04

品牌推荐 P07

Brand
Recommendations

05

商贸服务实用指南 P114

Business Services
Guide



About CBD Guangzhou 关于中国建博会（广州）

The China (Guangzhou) International Building Decoration Fair, hereinafter referred to as "CBD Guangzhou", was founded in 1999 and has been held consecutively for 26 years. CBD Guangzhou almost includes all top brands from China's building and decoration industrial chain, known as the "Debut Platform for Champion Enterprises".

This year, the 27th CBD Guangzhou will be held on July 8-11, at the Canton Fair Complex, Guangzhou. Spanning with an exhibition area of over 300,000 square meters, 2,000 exhibitors, 200,000 professional visitors from over 110 countries and region, CBD Guangzhou 2025 is expected to be the biggest home furnishing and building decoration fair in the world.

In 2025, CBD Guangzhou upgrades its layout into the "Three-Ecology" strategic framework of INTERIOR, EXTERIOR and MATECH, showcases home furnishings, smart home technology, doors and windows, bath and sanitary ware, materials, hardware, machinery, and coatings within a collaborative environment designed to spark innovation and facilitate meaningful industry connections.

The INTERIOR ecology champions "Customization + Design" with smart home technologies and intelligent systems representing the pinnacle of modern interior innovation.

The EXTERIOR ecology delivers comprehensive solutions for outdoor living spaces, recognizing that exterior environments now demand the same attention to detail as interiors.

The MATECH ecology presents transformative advances in materials, hardware innovations, and precision machinery that bridge industrial capability with refined aesthetic outcomes.

EXHIBITION AREA

300,000 m²

EXHIBITORS

2,000+

COUNTRIES AND REGIONS

116

PROFESSIONAL VISITORS

200,000

Exhibition Hall Layout / Floor Plan

A区 Area A

- 2.1 智能家居 / 智能照明 / 人工智能设计与应用
Smart Home / CBD Lighting / AI Design & Application
- 3.1 智能家居 / 智能安防 / 智慧办公及商用空间
Smart Home / Smart Security / Smart Office & Commercial Spaces
- 4.1 智能家居 / 智能锁 / 智能入户解决方案
Smart Home / Smart Lock / Smart Entry Solutions
- 5.1 商业公装·智能建造及工程五金馆
Commercial Building Decoration - Smart Construction / Engineering Hardware
- 5.2 商业公装·顶墙整装及户外休闲馆
Commercial Building Decoration - Ceiling & Wall / Outdoor & Recreation Lifestyle
- 2.2-4.2 整家定制 Whole House Customization

B区 Area B

- 10.1-11.1 智造装备馆 Woodworking Machinery
- 9.2-10.2 设计定制馆 High-end Design Customization
- 11.2 当代涂装设计馆 Contemporary Coating Design Gallery

广州国际卫浴博览会

Guangzhou International Bath and Sanitary Ware Fair

- 1.1 全卫定制/卫浴五金/局旧改主题区
Customized Bathroom/Sanitary Hardware

D区 Area D

- 17.2 入户门/庭院遮阳/门窗供应链
Entrance Door/Patio Shading/Door & Window Hardware & Accessories
- 18.2-20.2 系统门窗/门窗供应链
Systematic Door & Window/Door & Window Hardware & Accessories

C区 Area C

- 14.1 定制五金 Furniture Hardware
- 15.1 建筑装饰五金 Decorative Hardware
- 14.2-15.2 定制五金 Furniture Hardware
- 16.2 材艺·国际馆 International Hall -Hardware & Material
- 14.3-16.3 家居材料 Interior Decorative Material



HIGHLIGHT EVENTS & SCHEDULE

**中国建博会 (广州)
商务对接交流会**
CBD WORLD-CONNECT
BUSINESS MATCHING EVENT

活动时间: 2025年7月8日 (周二) 上午10:30-12:00
活动语言: 英文

**CBD WORLD-CONNECT
BUSINESS MATCHING EVENT**

10:30-12:00 A.M. JULY 8, 2025
MEETING ROOM 02, AREA A

01

THE PLACE
栖居之界
2025/07/08

**THE PLACE - HIGH-END RESIDENTIAL
DESIGN TRENDS EXHIBITION**

JULY 8-11, 2025
HALL 9.2-A1, AREA B

05

**CBD WORLD-CONNECT
INTERNATIONAL BUYERS NIGHT**

18:00-20:00 P.M. JULY 9, 2025
THE WESTIN PAZHOU

02



**CHINA HOME AI DESIGN
INNOVATION CONFERENCE**

HALL 2.1-A1, AREA A

06



ARCHI BOX

14:00-17:30 P.M. JULY 8-11, 2025
HALL 16.2, AREA C

03



**SMART HOME LIGHTING
CROSS-BORDER
ECOLOGY CONFERENCE 2025**

HALL 2.1-A1, AREA A

07

**CMF - COLOR,
MATERIAL & FINISHING**

09:30-12:30 A.M. JULY 8-11, 2025
HALL 16.3, AREA C

04



**"PEARL LINK" 2.0 - SOURCING
TOUR OF NINGBO WHOLE HOUSE
FURNISHING SUPPLY CHAIN COMPANIES**

Interactive Check-in Point:
BOOTH 4.2-16-(01-19), HALL 4.2, AREA A

08

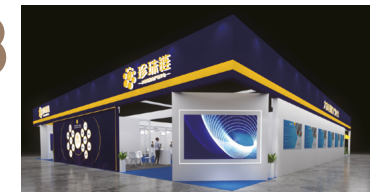

A [Hall 1-5] Area A



2.1

SMART HOME
智能家居/智能照明/AI设计与应用

4.1

SMART HOME / SMART LOCK
智能家居/智能锁/智能入户解决方案

5.1

COMMERCIAL BUILDING DECORATION - SMART CONSTRUCTION / ENGINEERING HARDWARE
商业公装·智能建造及工程五金馆

2.2-4.2

WHOLE HOUSE CUSTOMIZATION
整家定制

3.1

SMART HOME
智能家居/智能安防/智慧办公及商用空间

5.2

COMMERCIAL BUILDING DECORATION - CEILING & WALL / OUTDOOR & RECREATION LIFESTYLE
商业公装·顶墙整装及户外休闲馆



Area A 1.1-05, 2.2-20



Guangdong Meiao Group Co., Ltd was established in 2010. It is a modern group enterprise that integrates research and development, production, marketing, and service. Its products cover kitchen and bathroom hardware and stainless steel home customization, committed to creating a world-class manufacturer of highalloy materials for home furnishings.

With a new perspective of integration of professionalism and aesthetics, wisdom and practicality, it opens up a new era of smart home aesthetics and redefines "intelligence, home, and life". Since its establishment, Guangdong Meiao Group Co., Ltd has always adhered to the concept of "craftsmanship, intelligence, and quality like gold", with the goal of creating smart homes, driven by technological innovation, guided by market demand, and guaranteed by strong strength. It continuously innovates technological products and solutions in the cutting-edge innovation fields of kitchen, bathroom, and more home hardware industries, reshapes people's lifestyles, and leads new trends in kitchen and bathroom.

Guangdong Meiao Group Co., Ltd has a professional team with a global perspective and market development capabilities, utilizing cutting-edge technology to achieve automated manufacturing and standardized processes. It has obtained certifications from authoritative institutions such as ISO9001, CUPC, TUV, BSCI, and WATERMARK, SGS, etc. It demands exquisite quality according to international quality standards and endorses "Made in China" with word-of-mouth. Its products are sold in more than 50 countries and regions such as Europe, the United States and Canada, Southeast Asia, and Australia, bringing consumers an intelligent and humanized kitchen and bathroom life experience.



• under mount double ledge honeycomb sink



Area A 1.1-06



Guangdong Ousuo Kitchen and Bathroom Fittings Co.,Ltd. was established in 2016. It is located in Huangpu Town, Zhongshan City, Guangdong Province, 1 hour's drive from Guangzhou and 30 minutes' drive from Foshan. Osonoe is a high-tech enterprise in Guangdong Province, specializing in the research and development and manufacturing of stainless steel sink drainers, bathroom washbasin drainers and cup washers.

With the purpose of "innovating technology and creating value", the company strives to build industry benchmarks and build leading core competitiveness. Osonoe has met the product standards of many countries around the world, and uses the world's best product standards to serve consumers, making consumers more secure, convenient and trustworthy.

At present, osonoe has two factories with a total area of 260,000 square meters, more than 400 employees, and a monthly production capacity of more than 1 million sets, gathering a group of excellent technical and management talents. Support OEM and ODM services. The products have CUPC certification, WaterMark certification, EN274 certification and ISO9001 system certification.

Looking to the future, Osonoe will continue to serve customers and users with sincerity, set industry benchmarks with innovative technology and first-class quality with craftsmanship and creative practice, lead the future trend, and strive to create a better life for people.

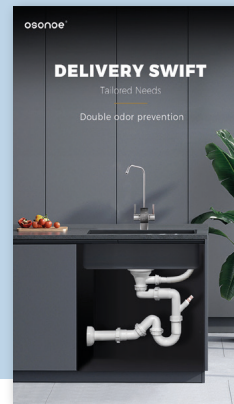

• 114mm P Trap Kitchen Sink Wall Drainage Pipe

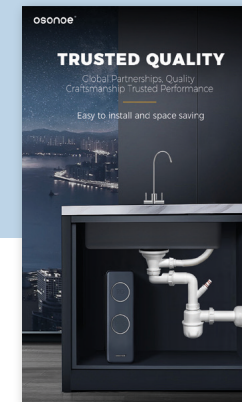

• 114mm Kitchen Sink Drain Bottle Trap



• Bathroom Wash Basin Drain

WeChat: 13392092020

Douyin: 广东美澳家居集团有限公司

WeChat Channel: 广东美澳家居

Official Website: www.meiaogroup.com

E-mail: manager@meiaogroup.com

Xiaohongshu: 美澳厨卫Meiaokitchen&bath

Facebook: <https://www.facebook.com/profile.php?id=100091308323201>

YouTube: <https://www.youtube.com/@Meiaokitchensink>

TikTok: https://www.tiktok.com/@meiao_sink?lang=en

Instagram: <https://www.instagram.com/meiaogroupsink/>

WhatsApp: +86 133 9209 2020

Facebook: Osonoe Plumbing

WhatsApp: +86 13410288246

TikTok: osonoe.ed

Douyin: oushunnuoxiaoshui

WeChat: 159133356102

1688平台网址: https://shop514867937103.1688.com/?spm=a2615.2177701.w_p_pc_common_topnav.0

Official Website: <https://www.osndrainers.com>

E-mail: 3773592517@qq.com



佛山市贸鑫铝业有限公司
FOSHAN MAOXIN ALUMINUM CO., LTD.

Foshan City Maoxin Aluminum Co., Ltd. is located in Nanhai District of Foshan City, known as the world capital of aluminum. We specialize in producing intelligent bathroom mirror aluminum materials, crystal ceramic painting oil paintings, bent aluminum, and more. Our modern standard factory covers over 10,000 square meters and is equipped with complete facilities from extrusion to surface treatment, enabling an annual production capacity of 10,000 tons of high-quality aluminum profiles. Currently, our company has a professional team of over

20 members with more than 5 years of industry experience. We offer custom services based on customer-provided drawings or samples, providing quotes within one hour and prototypes within about 10 days. Choosing us for mold making can save you 50% of your time, as time is money. We also provide considerate after-sales support. As an integrated industrial and trading enterprise, we are dedicated to serving you wholeheartedly!



• MIDDEE EAST LOCAL RICH SMARTMIRROR ALUMINUM



ZFANX

智有范全屋智能

Established in 2022, the brand ZFANX is a high-end brand specializing in whole-house intelligence. It is meticulously created by the original team from Apple's R&D system. The products of ZFANX cover smart home systems including smart central control screens, smart switches, heating, ventilation and air conditioning (HVAC) systems, security sensors, lighting systems, and more. ZFANX boasts 14 years of technological accumulation and over 200 patents. Relying on its simple and elegant product aesthetic design, stable and reliable technological advantages, and exquisite and meticulous manufacturing craftsmanship, ZFANX is dedicated to providing the ultimate and wonderful smart living experience for elite families worldwide.



• Z2 Luxe Couture Switches 智有范 Z2 轻者定制开关

• X5 Smart Switches 智有范 X5 艺境无双系列开关



• Smart Control Panel 智有范智能中控屏系列

WeChat:
+8615933198560

Facebook:
+14155906654

TikTok:
+14155906654

Official Website :
<https://www.foshanmaoxin.com>

Douyin:
15933198560guo

YouTube:
+14155906654

Instagram:
+14155906654

E-mail :
852036343@qq.com

Xiaohongshu:
A15933198560

WhatsApp:
15363410317

WeChat:
gh_4c55261aa746 (智有范全屋智能)

Official Website :
www.zxfans.cc

WeChat Channel:
sphmox6J21HYWV (智有范全屋智能)

E-mail :
edwin@lolai.cc





HONYAR 鸿雁

Founded in 1981, Hangzhou Honyar Electrical Co., Ltd. is subordinate to the China Electronics Technology Group Corporation (CETC), a centrally-administered state-owned enterprise, specifically belonging to the CETC Hikvision Group. It exemplifies the transformation and upgrading of key enterprises and serves as a benchmark for reorganization and development.

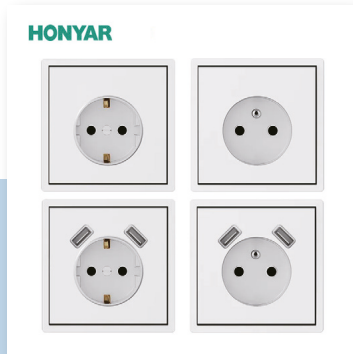

• EU Standard Switch and Socket



• Thailand Standard Switch and Socket



• UK Standard Switch and Socket



• Universal Standard Switch and Socket



BWEE 榜威

Bwee, founded in 2020, is an innovative technology brand specializing in wireless smart lighting. With its cutting-edge technology, patented innovations, and diverse market strategies, Bwee has quickly emerged as a standout in the industry. The company's core founding team hails from research institutes of world-leading lighting enterprises, and more than 50% of its workforce is dedicated to R&D. Currently, Bwee holds over 50 patents and intellectual property rights, and continues to focus on unlocking the vast potential of AIoT in the smart lighting sector.



• BWEE AMBIENT WHITE AND COLOR FLOOR LAMP



• BWEE RACE SERIES TRACK LIGHT

Official Website :
<https://www.hongyan.com.cn/>

E-mail :
13749@hongyan.com.cn

WeChat :
18143463550 陈仙芝

Official Website :
<https://www.bweeotech.com/>

E-mail :
kim.lok@bweeotech.com

WeChat/Tel :
18657590678

WeChat Channel :
榜威科技

Douyin:
榜威智能照明

Xiaohongshu:
BWEE榜威科技

WeChat:
榜威科技



Xiaolei小雷

LTECH founded in 2003, is the first A-share listed company in China's lighting intelligent control field; it has created a full range of lighting intelligent control categories: smart home/intelligent LED driver/LED controller.As a member of Apple's smart family, LTECH has a strong smart home ecosystem.It has not only opened up 4 major dimming protocols for

lighting: DALI/DMX/0-10V/Triac Controlled, interoperability with third-party wired system, but also docking with ecological platforms in domestic and international.At the same time, LTECH also created 4 black technologies: superhuman adaptive intelligent lighting, distributed scene storage technology, T-PWM® million-level dimming technology, RGBCW wide colour gamut and wide colour temperature adjustable spectrum technology.Comprehensive wired+wireless solution, covering the whole scenario of household and commerce.

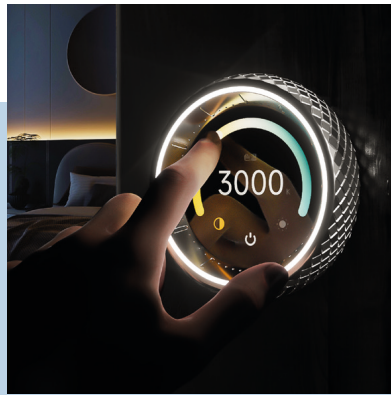

• Dubai Series-Super Smart Knob

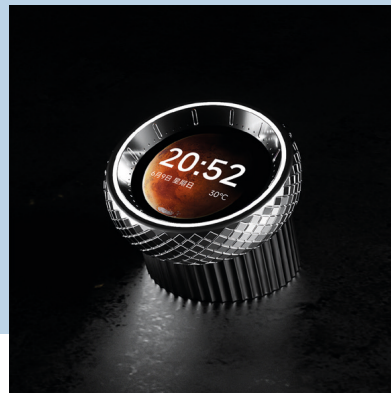

• Dubai Series-Super Smart Knob

LinkedIn:
<https://www.linkedin.com/company/ltech-technology>

YouTube:
<https://www.youtube.com/@ltechled15>

Official Website :
<https://www.ltech.cn/html/en/>

E-mail :
lt@ltech.cn



LENIO 徕丽

Zhongshan Jinteng Lighting Co., Ltd. is a lighting manufacturer integrating design, manufacturing, sales and service. It was founded in 2017 in Guzhen Town, which is known as the "Lighting Capital of China". It has launched nearly 1000 kinds of high - quality lighting and strictly abides by multiple manufacturing processes and testing standards to ensure product quality. And it has provided high - end lighting solutions for more than 1000 star - rated hotels, high - grade residential buildings and private villas. The vision has always been to become a well - known lighting brand in the industry.

The company has a 5000 - square - meter lighting industrial park and a more than 500 - square - meter head - office business exhibition hall, and it is a lamp production enterprise integrating lighting design, lamp production, sales and engineering. It has both non - standard and conventional production workshops, and makes strong R & D investment to ensure that Jinteng Lighting can maintain a luxury and noble style while achieving continuous innovation. In recent years, it has launched more than 1000 kinds of noble lighting. The company has successfully established a systematic industrial chain covering the R & D, production and sales of lamps, light sources, accessories and other related products. The precise market positioning has enabled Jinteng Lighting to win the bids for the lighting projects of five - star hotels, high - end buildings and government office buildings at home and abroad. Since the beginning of the new century, the company' s annual sales have reached new highs, and its comprehensive competitiveness has ranked first in China' s lamp industry.



• 徕丽 项链系列 90652 LENIO Necklace chandelier



• 徕丽 天际系列 90660 LENIO Skyline chandelier

Douyin:
LENIO

Tel:
18923314919

Official Website :
<http://www.jintenglighting.com>

E-mail :
sales01@jintenglighting.com
787576675@qq.com



Established in 1973, Hangzhou Hongshi Electrical Co., Ltd. is specialized in the production of British Standard, Chinese Standard electrical accessories and the development, production, sales of smart home products as well. With the registered capital of RMB 90 million, now its general assets exceed RMB 700 million. The company has one center for R&D and occupies more than 70000.00m², which already has a provincial enterprise research institute, with more than 900 employees, including 160 technicians. Our internal laboratory has CNAS qualification. The company now has the enough ability of self-developing, opening the tooling, manufacturing and quality management.



• Smart Wi-Fi/ZigBee Switch Breaker



• Smart Plug



• Smart Switch

Official Website :
www.hongshi-electrical.com

E-mail :
fangyf@hongshi-electrical.com

1688 平台网址:
https://shop5141867937103.1688.com/?spm=a2615.2177701.wp_pc.common.topnav

Lazada :
SWE SMART Store

TikTok:
SWE SMART Store

Tel:
Andy Fang 008618268151598

WeChat:
杭州鸿世电器

WeChat:
18268151598

Shopee:
SWE SMART Store



Foshan Silence Technology Co., Ltd. specializes in the R&D and production of soundproof pods, office partitions, and movable partition systems. We have established deep collaborations with leading domestic office furniture manufacturers, and our products have been exported to over 30 countries, including Europe and the Americas. Equipped with a complete production line, we integrate design, manufacturing, and sales to offer a diverse product range and customized solutions tailored to clients' needs.

We are committed to delivering high-quality, aesthetically pleasing office furniture, focusing on innovation and technology in the industry. Our advanced craftsmanship and exceptional service have earned us a strong reputation in both domestic and international markets. Moving forward, we will continue to innovate, stay ahead of market trends, and work hand-in-hand with clients to create better office environments.



Douyin:
赛轮斯隔音舱 83777513074

WeChat :
赛轮斯

Official Website :
<https://www.cnsilence.com/>

E-mail :
silence-xm@qq.com





Hisense

Founded in 1969 in Qingdao, Hisense is a world-leading technology enterprise with international brands including Hisense, Toshiba TV, and Gorenje. Generating RMB 215.3 billion revenue in 2024 (46.3% from overseas markets), it has ranked among China's Top 10 Global Brands for eight consecutive years. The company operates across four core sectors: Smart Living, Smart Energy, Semiconductors, and Automotive Electronics, powered by 31 global R&D centers and 36 production bases under its integrated "5+1" worldwide network.

Pioneering the industry-first RGB Three-Dimensional Color Control technology and deploying its self-developed StarSea AI Model for human-like interaction across all product categories, Hisense amplifies global influence through sponsoring five FIFA World Cup/UEFA EURO tournaments. Committed to operational carbon neutrality by 2050, it operates 1 Lighthouse Factory and 17 Green Factories, with four-time recognition on Fortune China's ESG Impact List.



• Hisense U6 Series Quantum Dot ULED TV



• Hisense U8 Series All-Round Flagship TV



• Hisense UX Series Flagship TV



ONLEAD 海太欧林集团

Established in 1996, ONLEAD specializes in designing, developing, and manufacturing furniture for smart offices, healthcare, education, and hospitality (hotels and apartments). We provide comprehensive commercial space solutions. Our commitment to the high-end market has earned us broad acclaim for our innovative designs, superior quality, and exceptional service.



• MOUNTAIN



• EDINBURGH



• EDINBURGH

Official Website :
<https://www.hisense.com/index.html>

WeChat:
海信爱家

LinkedIn:
Onlead Furniture

WeChat:
海太欧林集团

Douyin:
海太欧林集团

Xiaohongshu:
海太欧林集团

Weibo:
海太欧林集团

Official Website :
<https://www.onleadglobal.com>

E-mail :
jerry.yin@onlead.com.cn
尹先生 Jerry



Founded in 2015, Imou is a smart home product provider that aims at the smart IoT market for global consumers.

Focusing on home security field for 10 years, Imou provides smart cameras, smart door locks, home service robots, routers and many other smart home products for millions of families and enterprises around the world.

We have built four product lines: IMOU Security, IMOU Link, IMOU Robots, and IMOU IoT. Relying on the support of IMOU AI capability and cloud platform, we provide consumers with professional smart home products and services, and are committed to let every family enjoy a more convenient and safer smart life.



• Smart Lock K1-w



• IP Camera AOV PT



• Router HR12F-2

Official Website :
<https://www.imou.com/>

WeChat:
miao_makeit

Tel:
马明钰 海外品牌经理
13394056653
缪芹 品牌市场总监
17799862018

E-mail :
qin.miao@imou.com



LOGIC Office Furniture (ZHUHAI) Ltd. is a subsidiary of a large state-owned enterprise. For 38 years, we have been deeply involved in the office furniture industry. As one of the first leading brands to focus on high-end office furniture business, LOGIC has become a leading professional comprehensive furniture manufacturer and seller in the industry, LOGIC has a 120000 square meter smart factory, with the ability to manufacture a full range of office, medical, educational furniture and customize civilian furniture on a large scale, providing customers with a one-stop perfect office space solution. Committed to enabling a better space, Lizhi Furniture has many well-known customers at home and abroad, involving different industries such as finance, the Internet, and real estate, and has served more than 200 Fortune 500 enterprises such as Infineon, Siemens, Huawei, Sinopec, Lenovo, Tencent, and ByteDance all year round.



• 飞行家 Aviator



• 飞行家会议桌 Aviator Meeting



• 飞行家会议桌 Aviator Meeting

Official Website :
<https://www.crclogic.com>

E-mail :
marketing_gw@cnlogic.com.cn

WeChat :
励致家私

Tel:
0756-3382738



JIECANG, founded in 2000 in Zhejiang Province, China, was listed on the Shanghai Stock Exchange in September 2018. We specialize in developing, producing, and distributing linear actuator products. Our motto, "Technology Drives intelligent Life," reflects our commitment to innovation in various sectors such as intelligent office, medical care, smart home, and industrial automation. Especially in the Commercial and Home Height-Adjustable Desk Segments: JIECANG has pioneered industry standards for DC electrical linear actuators and height-adjustable tables in China, actively contributing to the establishment of standardized processes. Our global presence includes subsidiaries and factories in Asia, Europe, and the USA, covering 600,000 square meters and employing over 4,000 people. In 2024, we achieved a turnover of 3.6 billion RMB.

Commercial Market: As a key contributor to drafting industry standards for height-adjustable desks, JIECANG offers a comprehensive and highly modular product platform. Customers can flexibly combine our extensive range of modules and accessories to create desk configurations tailored to their specific needs, suitable for various application scenarios. JIECANG supports largescale, unified deployments, providing professional, complete desk solutions that meet multiple requirements including structural framing, wiring standards, and visual consistency. Home Market: JIECANG provides standard products covering all key home segments, such as gaming desks. For users with unique requirements, we offer full custom desk design services. This incorporates ergonomics, accessory selection guidance, spatial aesthetics, and smart operation to create a personalized smart home experience.

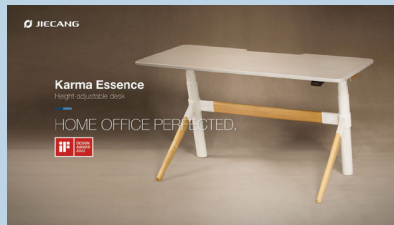

• Glide Standing Desk

• INVICTUS-S Gaming Standing Desk



XJ Schindler Elevator Co. Ltd (XJS) was established in 2001, now a Swiss Schindler Group holding company, Schindler is a fortune 500 company, XJS have all the core technologies of elevator industry. The company covers an area of nearly one thousand acres and has four subsidiaries and one escalator factory. With below ten major bases - technology R &D, driving system, main control system, elevator structural production base, vertical elevator assembly base, escalator assembly base, product testing center, logistics, skills training base, product operation monitoring center etc; we can provide various types of passenger lift, medical lift, glass lift, escalator, moving-walks, cargo lift, home lift and other elevator products and services, with an annual production capacity of 80000 units elevators.



WeChat: 捷昌驱动
 Douyin: 捷昌驱动
 WeChat Channel: 捷昌驱动

Weibo: 捷昌驱动
 Bajijiahao: 捷昌驱动
 YOUKU: 捷昌驱动

Facebook: Jiecang_Linear Motion
 YouTube: Jiecang_Global
 TikTok: Jiecang_Global
 Instagram: Jiecang_Global

LinkedIn: Jiecang_Linear Motion
 WhatsApp: Jiecang_Business
 Twitter/X: Jiecang_Linear Motion

Douyin: XJSchindler
 WeChat: XJSchindler

Official Website : <http://www.xjschindler.com/>
 E-mail : li.junchang@xjschindler.com



Soundbox was founded in 2008. We concentrate on new material development, digital noise canceling tech, and noise control and architectural acoustic construction. Being professional in technical solution offering and products R&D and manufacturing, Soundbox is leading company in acoustic field with global influence.

With a factory of more than 24000m², Soundbox ensures accuracy and reliability of technological data beginning from R&D to application under the help of professional instrumentation from the first acoustic testing room including advancing reverberation time testing and sound insulation testing in Chinese acoustic industry. Products are widely used in construction, industry, military and other fields.



• 静音舱 Movable Silence Booth

• 静音舱 Movable Silence Booth



• 静音舱 Movable Silence Booth

Official Website :
www.soundbox.hk

E-mail :
marketing@soundbox.hk



WeChat Douyin Xiaohongshu



Zhongshan Kaile Technology Co., Ltd. is an intelligent technology enterprise that integrates development, design, production, sales, and service. Over the years, it has been dedicated to the research and production of high-quality international engineering hardware with robust technical force, advanced production equipment, and exquisite manufacturing process. With its profound European design philosophy, it embodies fashion and dignity, which enables it to stand out in the fierce market competition and win the trust of millions of households.

Kaile has always adhered to the core business philosophy of 'outstanding achievements and contributions, "implementing the strategic policy of "revitalizing the enterprise with excellent talents, gaining benefits with excellent management, broadening the market with high-quality products, and winning customers with superior service." The company focuses on the details, striving to build its brand image while working hard on each intelligent lock. It is aiming for higher-level development.



• Paramey D7



• Paramey W1

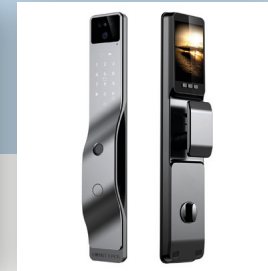

• Paramey F7

Official Website :
www.parameylock.com

E-mail :
business@parameys.com
pengxiaoyi@parameys.com

WhatsApp:
+8613265455160 +8618024253822

Facebook:
Guoping Chen

Douyin:
857321084138



Guangzhou Home Shield Guard Locks Co., Ltd.
 - established in 2016.
 - a professional manufacturer of IoT-based smart door lock and related devices.
 - provide OEM & ODM services, after sales services and maintenances.

Our main products are IoT-based fingerprint door lock, password door lock, hotel lock, access control, elevator controller, power switch and hotel lock system. 90% of our products are developed by our in-house R&D team.

We choose our business partners from the leading players in different regions to ensure the after sales services and maintenances in time.



• JD323T-24 IoT smart door lock



• JD323T-24 IoT smart door lock



• JD507TR IoT 3D Face door lock



Our group AIPU SAFE was founded in 1991, it is manufacturing conglomerate with a core focus on safes. After years of growth, it has emerged as a leading power house in the security industry, research encompassing and development manufacturing, and sales.

Advanced Fingerprint Sensor With Rapid And Precise Recognition Less Than 1S

This fingerprint safe features fast and secure verification, continuously learning about your fingerprint and adapting to the positions of your fingerprints.

Patented Unique Locking Bolt Design

Providing enhanced anti-pry performance compared to traditional basic safes.

When prying the door, it will deform slightly but the vertical guard will catch on the head of the door frame tightly, causing the bolt to remain engaged and preventing the safe from opening.

3 Ways To Open The Safe

You can use fingerprint scanner or digital keypad to open the safe. Additionally, it comes with two backup keys in case you forget the passwords.

- Passcode
- Backup Keys
- Fingerprint

Product Specifications

Model	V1-20T V1-20TS	V1-25T V1-25TS
External Height(mm)	200	250
External Width(mm)	300	350
External Depth(mm)	200	250
Capacity(Liters)	30	18
Net Weight(kg)	4.5	8

* Dimensions exclude handle, keypad and hinge or other projections.

Colors

Black

• V1 系列保险箱 V1 series safe

Official Website :
www.homeshieldsmart.com

E-mail :
carl.zheng@jiadunlock.com

Facebook: carl.zheng.73

Instagram: Luckycarl2011

Youtube: @carlzheng3286

LinkedIn: Carl Zheng

WhatsApp: +86-13531360189

Official Website :
www.aipuindustrial.com

E-mail :
levi@aipuindustrial.com

WeChat :
艾谱保险箱

Douyin:
艾谱官方旗舰店

Weibo:
AIPU艾谱保险箱

WhatsApp:
+86 15616560129

Facebook:
<https://www.facebook.com/profile.php?id=100093405547337>

YouTube:
<https://www.youtube.com/@AIPUSAFES-manufacturer>



WAHMEI Access Security Technology Co., Ltd., a wholly owned subsidiary of dormakaba Group, is the only production plant of Wah Yuet Group and the largest production and R&D base of dormakaba Group in China.

WAHMEI established in 1973 with 50-year of door lock and furniture manufacturing experience, the factory is located in the Greater Bay Area, Taishan City, Guangdong Province. At present, the total area of the facility is 330,000 square meters, with around 1,600 employees, which can produce more than 4,000 types of locks from raw materials to finished product assembly to meet the customer's one-stop customization needs.

As a National High-Tech Enterprise, Wah Yuet not only focus on technological innovation and sustainable development, also has awarded the international quality system certifications (ISO9001/14001/45001) and Intertek certification, which is committed to providing global customers with high-quality products and services in line with international ANSI/BHMA standards.



• S3A RFID 隐藏式酒店锁 S3A RFID Concealed Hotel lock



• ANSI 美式大拉手锁 ANSI Lever Door Contemporary Handleset



TLHM Co., Ltd., a wholly owned subsidiary of dormakaba Group, is the only manufacturing and R&D base in Taiwan. TLHM is located in Chiayi City, Taiwan. At present, the total area of the facility is 23,500 square meters with 250 employees. TLHM has highly vertical integration capability from product development, mold designing & fabrication, manufacturing, finished goods assembly and shipping that can highly support customers one-stop shop service. TLHM's product line includes all types of ANSI standard commercial grade 1 & 2 door locks. In the recent years, we have been further developing various mechanical lock platforms as foundation for ANSI electronic lock developments initiated by global well-known Access-control solutions providers and famous smart lock brands. TLHM has also awarded the international quality system certifications (ISO9001/14001/45001) and Intertek certification. Our vision is to continuously provide our customers with reliable products, professional services as well as commit to be a proactive and innovative world-class door lock manufacturer.



• 商用 ANSI 1 级电子插芯门锁 Commercial ANSI Grade 1 Electronic Mortise Lock



• 商用 ANSI 1 级电子门锁 Commercial ANSI Grade 1 Smart Lock

Official Website :
<https://wahyuet.com/>

E-mail :
info.cn@wahyuet.com

Hong Kong Office Tel:
+852 2739 5592

Head Office & Plant Tel:
86-(750) 5315688

Official Website :
<https://www.tlhmco.com>

E-mail:
sales.tw@tlhmco.com

Head Office Tel:
+886 5277 0688

Taipei Office Tel:
+886 22736 1698

OPPEIN 欧派

OPPEIN Home Group Inc., established in 1994, is the first listed enterprise in China's customized home furnishings industry to surpass RMB 100 billion in market capitalization. Originating from integrated kitchen cabinet solutions, the company has evolved over 31 years to develop a comprehensive portfolio spanning wardrobes, interior doors, bathroom suites, soft furnishings, kitchen appliances, aluminum doors & windows, furniture accessories, and whole-house customization solutions, solidifying its position as an industry pioneer.

bathroom suites, soft furnishings, kitchen appliances, aluminum doors & windows, furniture accessories, and whole-house customization solutions, solidifying its position as an industry pioneer.

OPPEIN operates Asia's largest customized home furnishings manufacturing base, with five intelligent production sites in Qingyuan, Tianjin, Wuxi, Chengdu, and Wuhan. Spanning over 3 million square meters, these sites achieve a daily production capacity exceeding 25,000 customized cabinets and an annual capacity exceeding 9 million units. OPPEIN's products are available in 130+ countries and regions, supported by a service network of 8,700+ global showrooms that continuously deliver its vision of "Where there is Home and Love, there is OPPEIN" worldwide.

■ The World's **Leading Whole-house Customization Brand**

- 31** Years in Home Furnishing Market
- 3** Million+ m² of Production Site
- 9** Million Cabinets Produced/Year
- 18,000+** Global Projects
- 146** Countries/Regions Serving
- 8,000+** Showrooms Worldwide

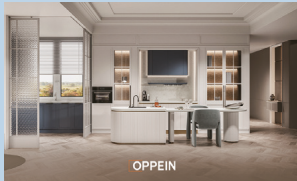

• Kitchen



• Walk-in Closet



• Whole-House Customization



• Interior Door



• Bathroom



• Gianstone·Martin 马丁橱柜 1



• Swift·Smart Kitchen 瞬储智厨—厨房收纳

In 2009, Gaston was officially established in Zhouzhuang Town, Jiangyin, Jiangsu, with a modern factory spanning 200,000 square meters of independently owned property. The main production equipment is imported from Spain and Germany, and the company strictly adheres to the ISO9001 international certification system for management and production.

Multiple inspection procedures are implemented according to international quality standards, making Gaston one of the earliest global brands to independently design, develop, and manufacture aluminum furniture. Leveraging the strong advantages of its parent group, Gaston has integrated the entire upstream aluminum industry chain. Today, it exclusively supplies aluminum home furnishings to internationally renowned five-star hotels, restaurants, luxury cruise ships, naval vessels, schools, hospitals, and more.

Gaston's aluminum furniture innovatively employs technologies such as 3D integrated wrapping, aluminum-wood fusion bonding, aluminum-paint solid coating, and aluminum-leather soft bonding. These techniques preserve the warmth and aesthetics of wood, creating a beautiful, eco-friendly, and long-lasting lifestyle while fully utilizing the advantages of metal—being "fireproof, waterproof, termite-proof, zero-formaldehyde, and corrosion-resistant." Currently, Gaston offers a full range of customized aluminum furniture, including wardrobes, kitchen cabinets, wine cellars, bathroom vanities, and whole-house solutions.

嘉斯顿 GIANSTONE

WeChat : 欧派集团官方

Weibo: 欧派集团官方

Facebook:@oppeinofficial
YouTube:@oppeinofficial

Official Website : <https://www.oppeinhome.com/>

Xiaohongshu: OPPEIN

Douyin: 欧派家居集团

TikTok:@oppeinofficial
Instagram:@oppeinofficial

E-mail : sales@oppein.com

WeChat Channel: OPPEIN

LinkedIn:@oppeinofficial
Twitter/X:@oppeinofficial

WeChat : 嘉斯顿铝制家居

Weibo: 嘉斯顿家居

Official Website : <https://www.gianstone.cn/>

Xiaohongshu: 嘉斯顿全铝定制家居

Douyin: 嘉斯顿全铝定制家居

Foreign Trade Manager: Mr. Jin
Tel: 13861791617

WeChat Channel: 嘉斯顿铝制家居

E-mail : 海外客服邮箱:sales@oppein.com

LESSO

LESSO is one of the big 500 in China and we're evenly listed in H.K. stock market (stock code: 02128. HK). China Lesso is a large domestic building materials group, a manufacturer of kitchen cabinets, furniture, sanitary ware, and doors.

More than selling just products, we offer one-stop service from site measurement to installation. For over 40 years, our company keep remarkable reputation globally, complete over 20000 projects in 100 countries.

We deliver the best values directly from our own factories (over 20,000 workers) with various international-standard testing certificates.

Being a source factory, we have a unique advantage. We can exercise strict quality control at every stage of production. From the selection of raw materials to the final assembly, every process is carefully monitored to ensure that only the best products reach our customers. Also, we possess all the necessary testing certificates in various countries, guaranteeing that our products meet the highest international standards.

If you are in need of our products, please do not hesitate to contact us. We eagerly look forward to the opportunity of collaborating with you the best products and services.



• Bathroom cabinet



• kitchen cabinet



• wooden door

索菲亞家居 SUOFEIYA

In 1981, Mr. Hassenfratz established Sogal France. Twenty years later, Suoifeiya introduced Sogal slidingdoor wardrobe in China, creating a new era for custom cabinetry. The past decades have witnessed Suoifeiya's leading position in international whole-home customization, with a diverse product portfolio that includes kitchen cabinets, vanity cabinets, interior doors, wardrobes, loose furniture, etc.



• 阿维尼翁餐厅 Avignon Pro Series Dining Room



• 非凡大师系列 Fayven Master



• 真我系列衣帽间 Real Me Series Cloakroom

WeChat: LESSO领尚

WhatsApp: +44 7901839700

Official Website: www.lesso.com

E-mail: lesso.simonli@gmail.com

Official Website: https://global.suoifeiya.com/

E-mail: sales@suoifeiyahome.com
sonia@suoifeiyahome.com

Pinterest: Suoifeiya Home

Facebook: Suoifeiya Home ; Suoifeiya Project

YouTube: Suoifeiya Home

TikTok: Suoifeiya Home

Instagram: Suoifeiya Home ; Suoifeiya Project

LinkedIn: Suoifeiya Home

WhatsApp: +8619966202249
+8618098179372

YESWOOD

YESWOOD is one of China's most renowned solid wood furniture brands. Founded in 2010 and now employing over 2,000 professionals, we integrate design, production, and sales to deliver high-quality furniture and home essentials, empowering everyone to create an accessible and fulfilling living experience.

Specializing in solid wood craftsmanship, YESWOOD offers over 20+ collections and 2,500+ SKU, spanning diverse aesthetics: from Japanese minimalism and Nordic simplicity to French vintage charm, modern luxury, retro elegance, Italian contemporary, and refined Neo-Chinese styles. Our products cover every corner of the home—living rooms, bedrooms, studies, dining areas, children's rooms—and are complemented by home accessories, mattresses, and custom furniture services.

Rooted in a human-centric design philosophy, we prioritize functionality, versatility, and timeless appeal. Each piece combines practical storage solutions, adaptable designs, and style-agnostic collections to harmonize with any interior theme. Whether enhancing small spaces or redefining grand homes, our creations aim to simplify styling while celebrating the natural beauty of wood. Driven by the vision to make "well-crafted living attainable for all," YESWOOD continues to innovate, offering thoughtfully designed solutions that bridge tradition and modernity, individuality and universality.



ZBOM

Founded in 1998, ZBOM HOME is a pioneer in China's kitchen cabinet industry. Now, ZBOM HOME focuses on the research and development, design, production and sales of the whole custom home. Starting from the brand concept of "knowing more about life", with the advantages of customized design and service of the whole family, we provide hundreds of millions of families with whole home solutions from the kitchen to the whole house.

As a professional home furnishing brand in the field of whole home customization, ZBOM HOME provides people with the integrated design, manufacturing and delivery business of the whole kitchen, whole house customization, wooden door wall panels, and finished home accessories, and has seven major production bases in the country, introduces foreign intelligent manufacturing equipment, integrates high-quality supply chains, and ensures that every link of products from design, production, installation to service is based on human scale and life as the core, creating ideal home products for global families.



• Chasing the future

WeChat :
源氏木语实木家居

Xiaohongshu :
源氏木语实木家居

Weibo :
源氏木语实木家居

Douyin :
源氏木语官方旗舰店

Official Website :
<https://www.yeswood.com/>

E-mail :
Vincent@yeswood.com

Official Website :
<https://www.zbomhome.com/>

E-mail :
Southeast Asia: SoutheastAsia@zbom.com

Middle East: MiddleEast@zbom.com

Canada: Canada@zbom.com

Australia: Australia@zbom.com

America: America@zbom.com

Eastern Europe: EasternEurope@zbom.com

LinkedIn: ZBOM Home Collection Co.,Ltd.

WeChat :
志邦家居

Douyin :
志邦家居

TATA木门

TATA Wooden Door, founded in May 1999, is a professional door manufacturing enterprise integrating R & D, production, sales, and service of living room doors. Over the past 24 years, TATA Wooden Door has been awarded the honorary titles "like Top Ten Wooden Door Brands in China" and others. For many times by virtue of fashionable and

minimalist product design as well as its perfect service system, and won wide praises in the industry and unanimous trust of millions of customers.

TATA Wooden Door has always insisted on taking innovation as the first driving force for development. From 2012, TATA Wooden Door would hold a new product release conference on December 22 every year, and has successfully developed and launched a number of functional wooden doors such as mute door, portrait door, warm core door, and fire door. Thus obtaining wide praises from the industry and the market.

By far, TATA Wooden Door has 5 major production bases and 29 factories all over the country, and provides strong production guarantees for customers by virtue of its advanced intelligent manufacturing equipment, inspection instruments, and standardized large-scale workshops.



• 铝玻 LB105 推拉



• 入户门 CK001



• 木门 @001 初见(瓷白色)



GoldenHome Living Co., Ltd. (Stock Code: SH603180) was founded in 1999 in Xiamen, China. We are a professional provider of high-end integrated kitchen cabinets and customized furnishings including Closet systems, Vanity Suites, and Interior Doors. GoldenHome specializes in R&D, manufacturing, sales, installation, and services of integrated kitchen cabinets and customized furnishings. We are committed to becoming the Prestigious Brand of Whole House Customization. We are the lead company as President of Kitchen Committee of China Furniture & Decoration of Commerce, and the Lead company as President of Kitchen Committee of China National Hardware Association, the honor member of NKBA. GoldenHome has nearly 4,000 high-end franchise stores all over the world. It owns Kitchen Cabinet, Wardrobe, Interior Door, Kitchen Appliance, Smart Home ..., to provide one-stop home solution experience for customers.



Wechat:
TATA木门官方) 原始id: gh_441c3fb7109e
(TATA木门官方服务) 原始id: gh_1ad44c0e01fe

Douyin:
(TATA木门) ID: TATAmumen

Weibo:
(TATA木门官方微博) ID: 2028958253

Official Website:
<https://www.tata.com.cn/>

E-mail:
liuna@tata.com.cn
sunwan@tata.com.cn
zhangjun@tata.com.cn
zhangchao@tata.com.cn

Wechat:
金牌官方号

WeChat Channel:
GoldenHomeLiving

Douyin:
金牌厨柜、金牌衣柜

Weibo:
金牌厨柜官方微博

Xiaohongshu:
金牌家居官方

Facebook:
<https://www.facebook.com/goldenhomelivingHQ>

Instagram:
<https://www.instagram.com/goldenhomelivinghq/>

LinkedIn:
<https://www.linkedin.com/company/goldenhomeliving>

YouTube:
<https://www.youtube.com/@goldenhomeliving>

<https://www.canc.com.cn/>
www.goldenhomeglobal.com

E-mail:
sales@goldenhomeglobal.com



Guangdong Xinhe Aluminum Co., Ltd., as a large enterprise of aluminum alloy building profiles in China, focuses on the R & D and production of building, decorative and industrial profile products. The brand "Xinhe Aluminum" is widely renowned and has won numerous honors, such as "National-level Single Champion Product in Manufacturing Industry (Decorative Aluminum Profiles)",

"Advanced Collective in the National Non-ferrous Metals Industry", "National High-tech Enterprise", "Top 10 Chinese Building Aluminum Profiles" (ranked sixth), "Top 10 Preferred Brands of Building Profiles" (ranked fifth), "Outstanding Contribution Enterprise in the Chinese Building Metal Structure Industry", and other honors. Meanwhile, the company has taken the lead in compiling and participating in the compilation of dozens of national and industry standards and is one of the founding enterprises of the National Non-ferrous Metals Intelligent Manufacturing Standards Working Group, demonstrating its outstanding strength.



• 建筑型材 ARCHITECTURAL ALUMINUM PROFILES

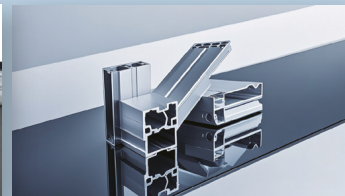

• 工业型材 INDUSTRIAL PROFILES

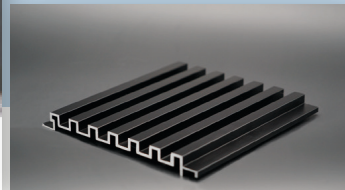

• 装饰型材 DECORATIVE PROFILES



Foshan Nater Import and Export Co., Ltd. Jinan Caiming Industrial Co., Ltd. – Global Leader in Advanced Wood Composite Solutions Jinan CaiMing Industrial Co., Ltd. is located in Zaoyuan Industrial Park, Zhangqiu District, Jinan City. Our factory specializes in the manufacturing of CDF (Compact Density Fiberboard), medium- and high- density boards, laminate flooring, and SPC flooring. As a government-certified key enterprise with dual . Core Strengths. Innovation at Scale with Complete Vertical Integration .

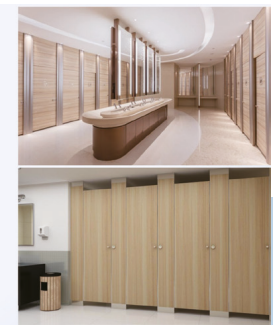
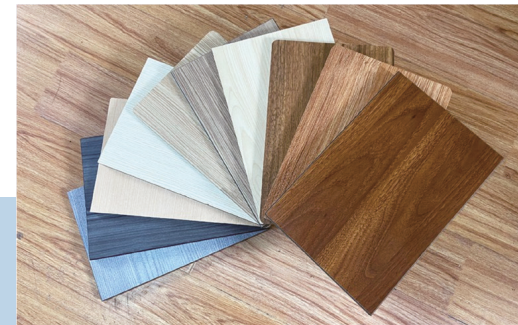

• Caiming Compact Density Fiberboard (CDF)

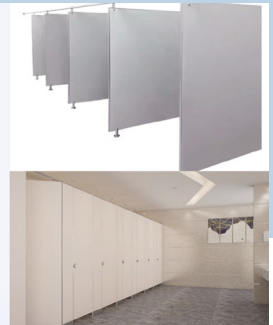

• Caiming PVC Co-Extruded Foam Board

Official Website : <https://www.xinhealuminium.com/>

WhatsApp: +86-13928634973

E-mail : xinhe@xinhe-alu.com

Tel: +86 189 2599 5021

Tel: +86 189 2599 5704

WhatsApp: +86 136 3006 9863

WhatsApp: +86 135 3397 1650



WhatsApp



DEDONG MATERIAL TECHNOLOGY CO., LTD. was founded in 2014. Its production base is located in Dongguan, the industrial manufacturing capital of China. It is a decorative line customization service provider specializing in the design, production, sales and service of plastic decorative trimming lines.

Quality is the lifeblood, continuous innovation and truth-seeking. After years of precipitation, the company has advanced production equipment and strong technical reserves, and its products sell well in domestic and foreign markets. The company's main decorative edge series products are widely used. It is widely used in wooden doors, cabinets and wardrobes, whole house customization, door and window building materials, top wall integration, automobiles and motorcycles, luggage and handbags, lighting appliances and other fields. Dedong products are easy to use, beautiful in decoration, and can be customized to provide you with one-stop service, saving you time and effort.

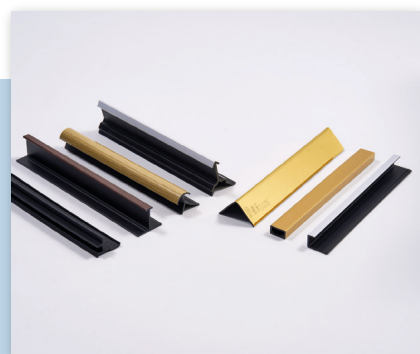

• SP 系列应用



• SP 系列应用图

Official Website : <https://dedongchina.1688.com/>

E-mail : chinadedong@163.com



Suzhou Greenish was founded in 2015. It is adjacent to the Taihu Lake Scenic Area. Its production base is located in Dongbang Town, Changshu, with a total area of more than 60000 square meters. The company relies on a professional team and advanced product technology to provide one-stop services such as acoustic design, decoration design, construction process design, and sound-absorbing acoustic products.

Has won honors such as National High tech Enterprise, Jiangsu Province Private Technology Enterprise GBA Golden Statue Best Green Building Unit, Suzhou Engineering Technology Research Center, A-level Tax Credit Enterprise, ISO9001, ISO4001, etc., and is a standard setter in the building materials industry in China



• Greenish Acoustic Printing wall panel



Official Website : www.grspanel.com

E-mail : ann.liu@grs-panel.com



Burgeree was established in 2007, located 60 kilometers from Shanghai Airport, specializing in the research, development, and production of PET architectural acoustic materials, as well as providing professional acoustic solutions. Burgeree holds over 400 intellectual property rights, and its products are used in venues with high demands for acoustic environments and aesthetics, such as Steelcase Armstrong, and Herman Miller. We honored with international awards including the Red Dot Award, Japan GOOD DESIGN Award, and the IF Design Award.



• 3D-完美编织 3D-Perfect knitting



• PET 标准版 - 12 毫米厚 PET plain panel - 12 thickness



Ctube is a technology-driven company specializing in eco-friendly piping solutions for construction, interior design, municipal infrastructure, and outdoor solar systems around the world.



Based in China, Ctube operates two advanced manufacturing plants and three intelligent logistics centers, ensuring large-scale production and fast global delivery. Our commitment to quality and sustainability is supported by certifications such as ISO 9001 and ISO 14001, and compliance with international standards including UL, CSA, AS/NZS, CE, IEC, and RoHS. We also hold more than 50 technical patents.



• 澳标波纹管 AS NZS 2053 PVC Flexible Conduit



• 美标 40 线管 UL Listed SCH 40 Conduit

Official Website :
www.burgeree.com

E-mail :
info@burgeree.com

Official Website :
www.ctube-gr.com

E-mail :
ctube@c-tube.net

Facebook/META: facebook.com/ctubeindustry
Youtube: youtube.com/ctubeofficialchannel

Insta-gram: instagram.com/ctube_official
LinkedIn: linkedin.com/company/ctube
Twitter/X: x.com/ctubeindustry
WhatsApp: +86 13925733207

Douyin:
材通管业

WeChat:
材通管通

B Area B

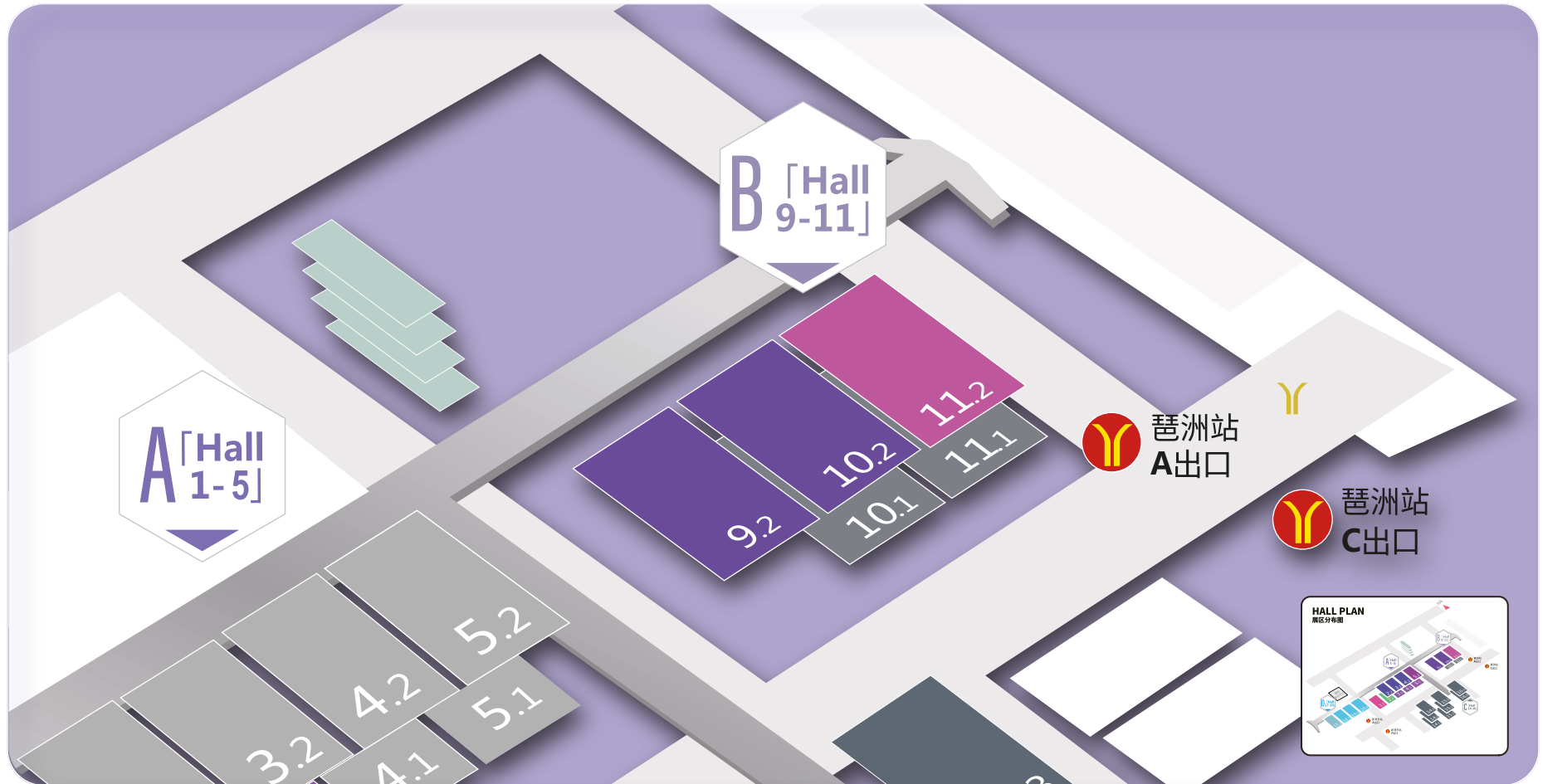

10.1-11.1

WOODWORKING
MACHINERY
智造装备馆

9.2-10.2

HIGH-END DESIGN
CUSTOMIZATION
设计定制馆

11.2

CONTEMPORARY COATING
DESIGN GALLERY
当代涂装设计馆

科耐银泰 KENI YINTAI

KENI , YINTAI Equipment (Shandong) Co., Ltd. is located in Ningjin County, Dezhou, Shandong Province, and has been plowing into the field of woodworking edge banding equipment for more than 20 years, and is a national high-tech enterprise integrating R&D, production and sales. With the core concept of "technology-based enterprise, innovation-based", the company focuses on providing the global furniture customization industry with total solutions for special-shaped edge banding and leading the innovation of special-shaped edge banding technology.

We have two independent brands "KENI" and "YINTAI Machinery". We have obtained 17 national invention patents and more than 100 utility model patents. Since the launch of "KENI" and "YINTAI Machinery" brand products, they have been exported to more than 80 countries and regions.



• KN810 封边机 curve edge banding machine

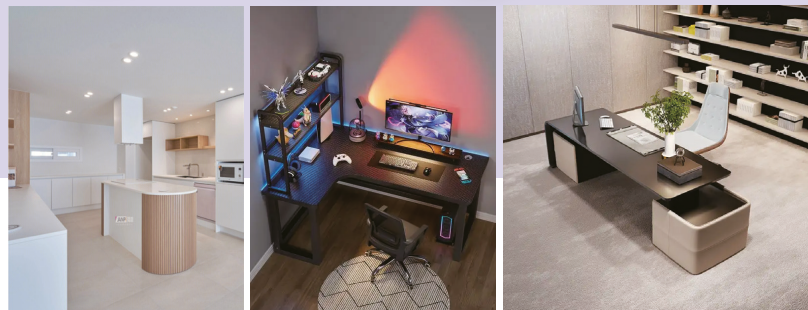

• KN810 异形封边机 curve edgebandingmachine 4 • KN810 异形封边机 curve edgebandingmachine • KN700-3 异形封边机 curve edgebandingmachine

Falit® 菲达

Wuxi Nanxing Equipment Co., Ltd. is located in the beautiful city of Wuxi, Jiangsu Province. Operating under the brand "Falit," it is a national-level specialized and innovative "Little Giant" enterprise and a high-tech company. With world-class production facilities and supported by a robust R&D system and design team, the company adheres to the innovative philosophy of "simplicity without compromise."

Dedicated to advancing China's intelligent manufacturing standards in the home furnishing industry, Wuxi Nanxing Equipment provides a range of premium products, including woodworking machining centers, computerized panel saws, laser edge banding machines, automatic edge banding machines, six-sided CNC drilling centers, and smart home furnishing production lines. These products are widely used in the manufacturing of cabinets, wardrobes, office furniture, wooden doors, and whole-house customization.

Committed to becoming the preferred high-end choice for more home furnishing intelligent manufacturing enterprises, Wuxi Nanxing Equipment strives to deliver excellence in innovation and quality.



• WCG2813LA(最新)

Douyin:
科耐银泰装备(山东)有限公司

Facebook:<https://www.facebook.com/profile.php?id=100082959207882>
YouTube:<https://www.youtube.com/@ShandongDongtengMachineryCoLtd>

WeChat:
科耐银泰

TikTok: @dtmach.machinery
WhatsApp: +86 15318816295

Official Website :
luna@sdzymach.com

Official Website :
<https://www.wxnanxing.com.cn>

E-mail :
wx181@falitmac.com

Tel :
18861825071



Guangzhou HUJUMP Adhesive Co., Ltd. is a company that specializes in the research, development, production, and sales of hot melt adhesive.

The main product series include PUR hot melt adhesive, EVA hot melt adhesive, SBS hot melt pressure-sensitive adhesive, and APAO hot melt adhesive series.

The products are exported to Europe, America, Australia, Asia, and other countries and regions, and a comprehensive global after-sales service system has been established.

We relentlessly pursue creating value for users in the field of hot melt adhesive solutions, and strive to seamlessly integrate our products into human life!



• PUR 聚氨酯热熔胶



• EVA 热熔胶

Official Website :
hujumpchemical.com

E-mail :
Ronny@hujump.com



PURETE is an automatic assembly line equipment service provider for painting and finishing. It is a high-tech enterprise focusing on environmental protection finishing applications. Designed to provide customized services for different types of customers at different stages of development, in order to meet different surface process needs, to provide professional coating and finishing equipment manufacturing and technical services. PURETE's production line equipment covers roller coating line, curtain coating line, spraying line, inert coating line, laminating line, wrapping line, excimer super matt line, etc.

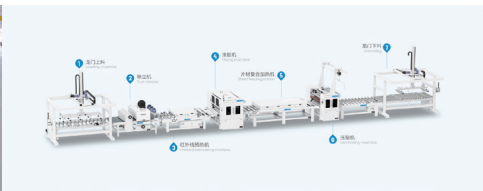

• PUR lamination production line
PUR resin paste PP, PVC, PET, PETG and other rolls and sheets.



• Reciprocating spraying production line
It can be UV- and water-based, and can achieve various processing techniques to meet customization needs

Official Website :
www.puretegroup.com

E-mail :
marketing@puretegroup.com

Whatsapp : +8613825503312

LinkedIn:
linkedin.com/company/
foshan-shunde-purete-mechanical-co-ltd

Facebook :
https://www.facebook.com/profile.php?id=100078022944063#

YouTube :
https://www.youtube.com/@puretemachinery7548

Instagram :
instagram.com/purete2022





Our company is a manufacturer specializing in providing automated equipment for intelligent flexible production lines for wooden doors, panel furniture, new materials industry, and bamboo and wood panels. We have independent R&D and after-sales service teams to provide customers with professional pre-sales and after-sales services.



• Product Image(s)

• Product Image(s)



Taian Zhanhong Woodworking Machinery Co., Ltd. is one of the largest manufacturers of vacuum camber film covering machines and sheeting machines in China. We made woodworking machine since 1994. Close to national highway 104 and Jinghu expressway, we have more than 80,000 square meters of land and over 200 employees including superior designers.

We are one of the few manufacturers who can develop TM2680 series curved surface vacuum hot membrane presser successfully in China at present, which is appraised as the "famous brand product" by National Woodworking Machinery Quality Supervise and Check Center.





As one of the leading door manufacturers in China, which established in 1989. Through 30 years of development, MEXIN has established a complete organizational with 6,000 employee and including technique research, manufacture, marketing and after service departments. Main products cover fire rated doors, safety security doors, commercial doors, Interior MDF doors, solid wooden doors,

automatic garage doors and industry doors. By positive technique research and international market exploration, MEXIN have successfully entered to over 50 countries. Such as US, UK, European countries, Middle East and South Asian countries, and in good reputation. It helps MEXIN keeping stable business relationship with customers in these countries and regions.

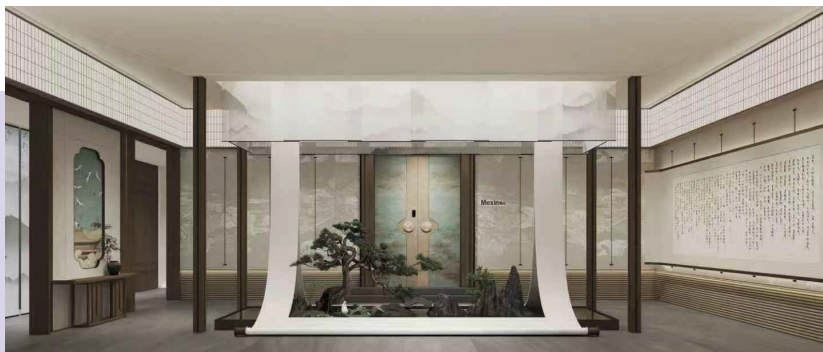

In 2007, the "Xingcheng" brand was established in Guangzhou. It was the first enterprise to introduce high-quality sliding doors to China and was hailed as a leading figure in the Chinese cabinet door industry. In 2011, with advancements in product technology and changes in the market environment, we kept pace with industry trends and invested in a customized wardrobe vacuum forming

sliding door production line. The "Xingcheng" brand became renowned nationwide. In 2018, the company independently developed an MDF electrostatic powder spraying production line. In 2021, we obtained the international quality management system certifications: ISO9001, ISO14001, and ISO45001, as well as SGS and FSC.

In 2023, we realized the integration of doors, walls, and cabinets: applying electrostatic powder spraying technology to cabinet doors, room doors, wall panels, arcs, and cabinet bodies, with an expansion into the office furniture. Xingcheng has production bases in Guangzhou and Foshan, focuses on healthy home solutions, continuously innovates, and is committed to becoming a high-tech, eco-friendly enterprise that promotes ecological and healthy living environments.



• 双人位升降桌



• 柜门 - 法式摩登

Official Website :
<http://www.mexindoors.com/>

E-mail :
Dean@mexindoors.com
Kyle@mexindoors.com
Moniquemou@mexindoors.com
JohnsonLV@mexindoors.com

Official Website :
www.xytc.com.cn

E-mail :
bella@gzxccheng.com

WhatsApp
+86 13710326115



Hangzhou Shidian Intelligent Sunshade Technology Co., Ltd., founded in 2004, is a pioneer in functional curtains and a comprehensive solution provider for indoor and outdoor shading products. With outstanding R&D capabilities, advanced production technology, superior product quality, and efficient team services, the company offers a wide range of premium products including manual and smart residential/commercial roller blinds, Venetian blinds, sheer shades, Shangri-La shades, honeycomb shades, Roman shades, and skylight solutions. It is a leading brand in China's sunshade industry.

The company operates four self-owned production bases (Hangzhou, Chengdu, Qingdao, Anji) and over 100 direct service offices nationwide. With an in-house service network (no third-party outsourcing), it serves nearly 500 cities across China.

The company operates four self-owned production bases (Hangzhou, Chengdu, Qingdao, Anji) and over 100 direct service offices nationwide. With an in-house service network (no third-party outsourcing), it serves nearly 500 cities across China.



• 无拉绳卷帘



• 无拉绳柔纱帘



• 无拉绳蜂巢帘



• 无拉绳蜂巢帘



Founded in 2011 in Hangzhou, Manycore Tech Inc. is a spatial intelligence enterprise powered by artificial intelligence (AI) technologies and purpose-built graphics processing unit (GPU) clusters. Through years of technological innovation, we has developed a physically accurate world simulator, which has been applied in real-time rendering of indoor space scenarios, industrial production and manufacturing, and training of virtual physical worlds.

Coohom is a spatial design software product owned by Manycore Tech, developed for international users and customers, providing 3D cloud design software and rendering services to global home retailers, manufacturers, and interior designers. Currently, Coohom supports 14 languages, including English, Korean, Japanese, and Spanish, and serves users and customers in over 200 countries and regions around the world. For its unique features and industry-leading technology, Coohom was recently recognized by G2, a globally renowned software rating platform, as the software earning the titles of "Leader," "Most Implementable," and "Fastest Implementation" in the 3D rendering category for 2024.

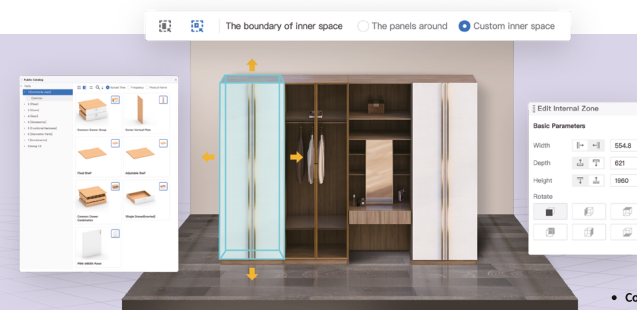

• Coohom Design Tool

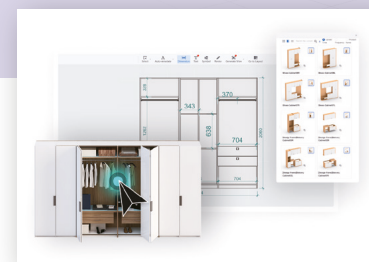

Official Website : <https://www.worldshidian.com/>

E-mail : bruce917@outlook.com

Douyin : 世典智能遮阳

WeChat : 世典智能遮阳

Xiaohongshu : 世典智能遮阳

WeChat Channel : 世典智能遮阳

Official Website : <https://www.coohom.com/b2b>

E-mail : Sales@Coohom.com

LinkedIn: Coohom

Facebook: Coohom

Contact Person: 乐布 Jessie

Tel: 18760102090

WeChat: LAIY_211

Segger 希爵

Xijue's whole house customization is deeply rooted in the light and high customization OEM track, focusing on in-depth research and development of door and wall cabinet systems, and building a new paradigm of woodworking intelligent manufacturing with the dual engines of "technology driven+ecological collaboration". Since its establishment in 2016, relying on

the hard core strength of a 220000 square meter super intelligent factory, we have built a full chain digital system from design deepening to agile delivery. We have provided strategic level supporting services to more than 1000 design agencies and integrated enterprises nationwide, and delivered over 200000 sets of customized private housing cases annually.



• 门墙柜 1 (Door and wall cabinet)



• 门墙柜 3 (Door and wall cabinet)

Official Website :
www.xijuedoor.com

Tel :
18580313178



wechat



DEB 德貝 CUSTOMIZED 全屋定制

DEB Customization - A Leading Chinese High-End Custom Furniture Brand. Founded in 1994, DEB has consistently pursued a premium product strategy with the long-term vision of becoming a centennial brand. By prioritizing user experience and aerospace-grade craftsmanship, DEB creates emotional resonance through every product interaction.

With over 100 patents and continuous innovation, DEB collaborates with global top-tier suppliers to integrate cutting-edge international designs. Our comprehensive solutions include customized furniture systems, kitchen & bath systems, unbound systems and finished furniture systems—seamlessly integrating products into living spaces.

DEB operates a 150,000-square-metre industry 4.0 smart manufacturing base with world-class equipment. This intelligent production system, combined with user-centric design, transforms functional spaces into artistic expressions of ideal living.



• 千屿 NEXISLES



• 隐野 WILDZEN



• 德贝工厂新航拍图

Official Website :
<https://www.deb.com.cn>

Email:
debcustomization@deb.com.cn

Head Office Tel:
+86 5277 0688

Taipei Office Tel:
+86 22736 1698

WeChat:
DEB德贝定制

Douyin:
德贝全屋定制

WeChat Channel:
德贝实业

Xiaohongshu:
德贝全屋定制、德贝定制家



Sunvega
三 | 维 | 家

Founded in 2013, Sunvega Information Technology has built SaaS solutions for the home furnishings industry, covering design, manufacturing, and CNC machining. These solutions are powered by three core self-developed engines: AI Cloud Modeling, AI Cloud Rendering, and 3D Vector AI.

The company continues to invest heavily in R&D, with 294 patents filed and 259 copyrights granted. Sunvega serves over 20,000 businesses in the home furnishings sector, and more than 9,000 manufacturers use its cloud-based manufacturing systems.

The company has secured investments across four funding rounds from leading investors, including SoftBank China, GF Xinde Investment, Red Star Macalline, Alibaba, CAS Investment, and Inovance Technology. As Sunvega expands its global presence, its wholly owned subsidiary JEGA now leads the company's international operations, with more than 20 local teams established overseas to provide dedicated services.



FURNI AI
Home Renovation Tool

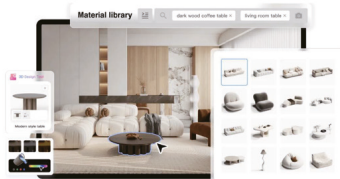

JEGA AIHOUSE
3D Design Platform

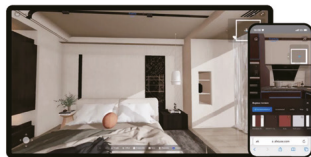

JEGA VISIONEER
Virtual Showroom

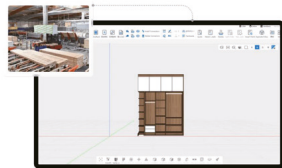

JEGA CLOUD FACTORY
Manufacturing System

• JEGA



SEAJOIN 奢匠

SEAJOIN is a long-standing custom home furnishing brand that integrates research and development, design, production, sales, and service. With over 17 years of experience in woodworking, the group offers a wide range of products, including wood doors and wall panels, custom wardrobes, custom cabinets, and soft furnishings, catering to the one-stop shopping needs of consumers. SEAJOIN has established four production bases, spanning a total area of 400,000 square meters. Its robust manufacturing system enables large scale and automated production lines, ensuring efficient nationwide delivery capabilities.

Over the years, SEAJOIN has earned widespread recognition in the industry and the trust of millions of users by leveraging its unique "door-wall-cabinet integration" approach and comprehensive service system. Looking forward, SEAJOIN remains committed to its brand philosophy, "Home is the greatest masterpiece," striving to build a world-class custom home furnishing brand and create a better living environment for consumers worldwide. Our dedication continues!



• Minimalist Elegance Natural Series



• Minimal Elegance MANAUS SERIES

Official Website :
www.aihouse.com
www.3vjia.com

YouTube:
JEGA AIHouse Official

Wechat&WeChat Channel:
三维家

Facebook:
JEGA AIHouse Global

Email:
wesupport@aihouse.com

LinkedIn:
JEGA AIHouse

Douyin:
三维家软件

Instagram:
aihouse_official

Official Website :
<http://www.luxury2008.com>
<https://seajoincabinetry.com/>

Facebook:
Seajoin Cabinetry

Instagram:
Seajoin Cabinetry





MACIOPLUS provides elite with high quality and crafted lifestyles, its philosophy is Beyond Extraordinary.

It integrates Italian aesthetics with precision craftsmanship and delivers ideal home solutions for elites.

MACIOPLUS advocating the minimalist balance between functionality and aesthetics, we offer exceptional quality, superb craftsmanship, and comprehensive functionality. Our design serves the people and events that flow through the space, starting from the authentic needs of consumers to create personalized and artistic home spaces.



• "HENG" Series Product Introduction



• "HENG" Series Product Introduction

Foshan Rewin Applied Materials Co., Ltd. is a whole-house storage brand that holds exclusive rights to the BASISTEM brand. The company is responsible for product R&D, upgrades, manufacturing, brand operations, sales, and the integration of service systems for this brand. Guided by its corporate vision of "Bringing Tidy Ordered Beauty into Each Home," the company continues to innovate and grow.



Market Position. Foshan Rewin Applied Materials Co., Ltd., under the brand BASISTEM (Chinese transliteration: 巴斯蒂姆), is a world-class premium integrated whole-house storage system provider and manufacturing expert. It caters to families who value an elegant lifestyle by offering R&D, production, sales, and services for home storage solutions. In the specialized field of whole-house storage, BASISTEM ranks as an international first-tier brand. It collaborates comprehensively with leading home furnishing brands worldwide, including those in China, to deliver complete storage system solutions for high-end customized products. Competitive Advantages. Innovation: R&D as the Foundation of the Business Foshan Rewin Applied Materials Co., Ltd. prioritizes innovation as its core competitive edge and foundational principle. With its dedicated engineering R&D center, the company consistently launches products that set industry trends.

• Lugano 卢加诺系列衣柜收纳解决方案



• Schiers 希尔斯系列地柜及岛台解决方案



Official Website :
<https://en.macio.com.cn/>

E-mail :
365927159@qq.com



E-mail :
Jenny: jenny-xu@basistem.com

Lily: lily.luk@basistem.com



科凡高定

柜 墙 门 整 体 定 制

Founded in 2006, Kefan is one of the top ten whole-house customization brands in China. It is the honorary chairman unit of the Guangdong Wardrobe Industry Association and the Executive Chairman Unit of the Custom Home Special Committee of the All-China Federation of Industry and Commerce Furniture Decoration Industry Chamber. Kefan is an integrated service provider offering a comprehensive

customization solution for cabinets, walls, and doors, encompassing home research and development, design, intelligent manufacturing, and services. It is a light luxury customization brand widely loved by designers and consumers. As one of the pioneers in promoting the integrated customization of cabinet, wall, and door systems, Kefan has always adhered to the product value of "aesthetics first, high quality at a reasonable price." By combining the six major product systems of custom cabinets, wall protection, interior doors, lighting kitchen and bathroom fixtures, and soft decorations, Kefan provides a multi-dimensional layout that covers the home needs of consumers comprehensively. In 2022, Kefan was honored with the Italian A'Design Award & Competition foresightedness. This award is based on the functionality, aesthetics, innovation, and feasibility of the work, which aligns perfectly with the product values that Kefan has always upheld.



• 长者公寓



• 酒店标准客房



LANDBOND CORTEN

LANDBOND CORTEN, a joint-venture between Landbond group(china) and Corten Furniture International (Singapore) has been a leading player in the customized home furnishing scene since its establishment in 2004.

LANDBOND CORTEN's philosophy has always been to provide our customers with efficiency and proficiency, We aim to provide personalized space solutions to our customers both in looks and functionality.

Our Vision embraces technological improvement and craftsmanship a perpetual strength of the Company, Technologically advanced materials, quality finishes and ongoing design research have made LANDBOND CORTEN leaders in a sector marked by increasingly fierce competition.



• 现代橱柜 Modern kitchen cabinet



• 现代电视柜 Modern TV cabinet



• 现代衣帽间 Walk-in Wardrobe

WeChat:
科凡高定

Douyin:
kefans

Official Website :
www.kefan.cn

E-mail :
3233854696@qq.com

Official Website :
www.lbcorten.com
www.landbondcorten.com

E-mail :
lbcorten_export@163.com

WeChat:
联邦高登全屋定制

Douyin:
联邦高登

Weibo:
联邦高登全屋定制

Xiaohongshu:
联邦高登全屋定制

WeChat Channel:
联邦高登全屋定制

SENG CUCINE focuses on the design concept of Italian minimalist elements, uses Italian aesthetics to create a social and creative kitchen lifestyle, and conveys the "Inspirational Kitchen Life Philosophy" to users, so as to inspire and motivate our customers to explore new lifestyles, ignite their passion and inspiration for kitchen life, and create infinite possibilities for a better life.

With globally leading intelligent manufacturing and 20 years of metal processing technology experience, we integrate domestic and foreign design resources and innovatively combine ultra - thin stainless steel with solid wood, slate, coated glass and other materials to provide users with personalized space solutions with fine - crafted quality.

The innovative process research and development of SENNG CUCINE never stops. The 12MM ultra - thin cabinet board interprets the aesthetic pursuit of Italian - style minimalism. The 3D embossed texture door panel brings the story of nature into the home. The one - piece bending arc process carefully protects the safety of family members..... We believe that original design and technological innovation need to serve users' life experience, and products always emphasize the combination of user experience, function and aesthetics.



• Late Afternoon (Kitchen Cabinets)



• Astral Plane (Bathroom Cabinets)

Founded in 2017, Impressionist Whole House Customization stands as a leading player in the soft furnishings industry. As one of the first members of the "Foshan-made in Every Home" Industry Alliance, it is a whole-house customization brand under the esteemed Molike Group. Boasting unique resource advantages and robust brand backing, Impressionist offers a one-stop, comprehensive solution, integrating R&D, manufacturing, sales, construction, and after-sales services. Its product range spans textiles, furniture, customized items, doors, windows, and coatings. The brand provides a full suite of professional services, including one-stop home decoration material selection, expert design, and meticulous construction management, effectively addressing diverse home decoration needs of consumers.

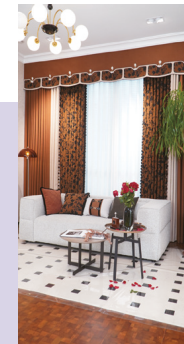

• Floral Vine Crystal



• Floral Vine Crystal



• Bamboo Swaying Shadows

WeChat:
SENG_CUCINE

Xiaohongshu:
920438849

TikTok:
SENG666888

Official Website :
www.sengcucine.com

E-mail :
export@sengkitchen.com

Official Website :
<http://www.molikgroup.com>

E-mail:
917860837@qq.com



WeChat

Douyin

Xiaohongshu

WeChat Channels



Foshan City Wanlei Building Paint CO.,LTD, was founded in 1991 in Foshan, China. We are an enterprise with nearly 30 years of experience in paint R&D, manufacturing and service, and have served more than 20 different brands for this purpose, forming a stable partnership.

100% self-developed technology, 31 years of stable quality craftsmanship, more than 200 paint categories to choose from, covering 4 major categories of

exterior stone paint, microcement, resin stone and epoxy paint. All the elements allowed us to successfully create a one-stop brand supplier of wall coating solutions exclusively for interior and exterior.

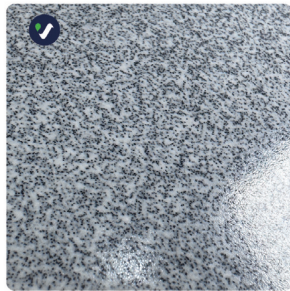

• epoxy color sand floor paint- 环氧彩砂

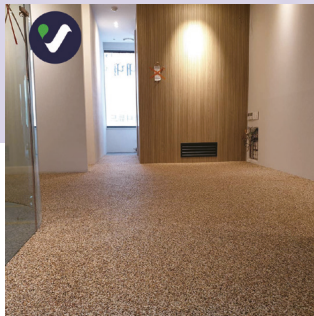

• resin washed stone- 水洗石



WeChat:
wanleituliao1991

Xiaohongshu:
万磊涂料

Douyin:
万磊涂料

Instagram:
vanlei_paint
vanlei_official
vanlei_apply

YouTube:
Vanlei Paint

Official Website :
<https://www.fswanlei.com/>

E-mail :
Rita@fswanlei.com

Tiktok:
vanleipaint

Facebook:
Vanlei Paint

whatsapp:
+86 13823401617

C Area C

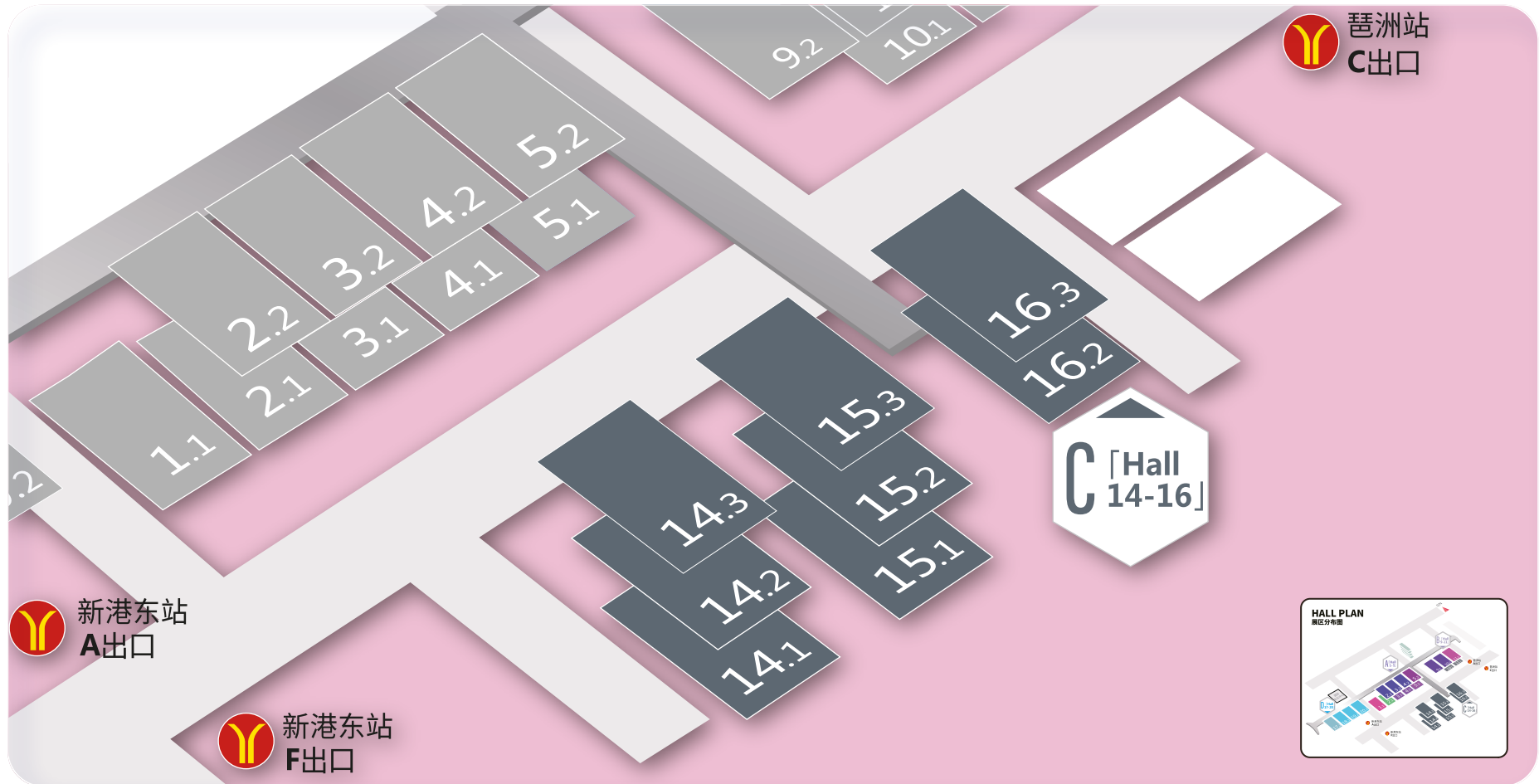

14.1

FURNITURE
HARDWARE
定制五金

14.2-15.2

FURNITURE
HARDWARE
定制五金

16.2

INTERNATIONAL HALL -
HARDWARE & MATERIAL
材艺·国际馆

14.3-16.3

INTERIOR DECORATIVE
MATERIAL
家居材料

15.1

DECORATIVE
HARDWARE
建筑装饰五金



Guangdong Jieyang Tenghua Hardware Products Co., Ltd. is a large-scale enterprise specializing in the production of fasteners and furniture accessories. Since the research and development of "cold rolling eccentric wheel with internal and external teeth" in 2021, the products have been recognized by the industry for their excellent anti-skid and stability. The company is equipped with small/large wire drawing equipment, Taiwan Province screw/nut machinery, multi-station cold heading and automatic punching machine. Relying on high-quality team and strict management, the company adheres to the development concept of "paying equal attention to quality, technology, scale and service" and deeply cultivates the industrial value of "small accessories, big articles". The products sell well all over the world. We sincerely invite friends from all walks of life to visit us for guidance, cooperation and win-win cooperation!



• 三合一



• 自攻



Chengdu Xingruishi Intelligent Technology Co., Ltd. is headquartered in Chengdu Shuangliu, — the capital of aviation economy in China. With a traceable history of more than 17 years in the home furnishing industry, it is an innovative manufacturing enterprise integrating R&D design, production and sales, service and training, empowering home furnishing enterprises and commercial institutions with high quality and efficiency to realize intelligent electric furniture.

Currently, the company holds over 100 core patents. On the design side, it has achieved modular and standardized product output. On the application side, it has overcome industry challenges such as easy deformation of panels after integrating furniture and smart electric hardware, as well as issues related to design application, installation control, and usage safety. The company has received widespread praise from both the industry and customers and has now entered into strategic partnerships with many well-known domestic home brands!

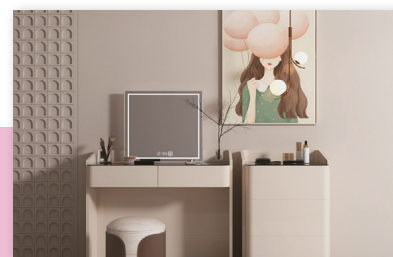

• Finished intelligent lifting mirror cabinet



• NF-PRO-ZR303

Douyin:
揭阳市腾桦五金制品有限公司

Email:
amartenghua@163.com

Official Website:
www.xingruishi.com

Email:
1170909721@qq.com

Xiaohongshu:
RUI SHI 锐世
锐世智能五金

WeChat Official Account:
锐世智能电动五金

Douyin:
RUI SHI 锐世智能五金

Kuaishou:
RUI SHI 锐世智能五金

WeChat:
15881045490

WeChat Channel:
锐世智能五金3561

Jinritoutiao:
锐世智能五金RUI SHI

Bilibili:
RUI SHI 锐世智能五金

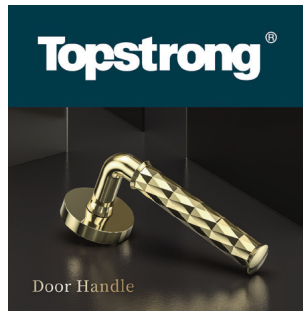

Topstrong Hardware, established in 2002, was listed on the ChiNext A-share market of the Shenzhen Stock Exchange in 2018 (stock code: 300749).

For 23 years, we have been focusing on the research and development, production, and sales of high-quality hardware. We are a provider of customized hardware system solutions for the whole house, with three categories and six system product systems: door hardware, basic hardware, storage hardware, profile hardware, lighting system, and wall protection system. We can meet the needs of integrated development of door and wall cabinets, whole house customization, and even whole house products, and are committed to allowing consumers to enjoy a beautiful home life.

Topstrong has three major production bases in Zhongshan, Foshan, and Wenzhou across the country, and its marketing network now covers 34 provinces, municipalities, and autonomous regions, with over 1000 standardized terminal outlets. The company focuses on product research and development, technological innovation, and customer service, and has been awarded honors such as "National High tech Enterprise". It always adheres to the principle of "Topstrong, peace of mind", takes the market as the guide, and continuously creates value for customers.



Official Website:
<https://www.topstrong.net/>

Email:
wang_fan@topstrong.com

Tel :
18024212004 Evan 王先生

TUTTI, founded in 2006, is a large professional household hardware system service provider, integrating R&D, design, intelligent manufacturing, marketing and after-sales service.

With household hardware as the core, TUTTI focuses on the R&D and intelligent manufacturing of hardware products such as hinge, drawer slide, double wall drawer, sliding door system, kitchen and wardrobe

storage, sink and faucet, and is committed to provide a whole house hardware solutions. As the head brand of China's home hardware industry, TUTTI shows the strength of China's manufacturing to the world.

TUTTI 图特



• 巴赫收纳 BACH-KV-1



• 口袋门 T925-KV-1



V'STE

意大利·威思特

VSTE has been dedicated to the development and production of architectural hardware components over 20 years. We use standardized production base, with lock-making workshops, precision casting workshops, surface decoration special craft workshops, etc.

We offers variety of products which can meet your multifarious demands including 304 stainless steel, space aluminum, zinc alloy and other series of

locks. Our products' design is novel, the combination is wonderful with excellent quality, which has been exported to all over the world including South America, the Middle East, Western Europe and other countries and regions, getting unanimous approval.

SEZAO is a high-end brand officially launched in 2022 by HEGU. At present, it has four series of products: hinge, UM slide, ball bearing slide and tandem box. The product series uses the latest technology and equipment, special line production, the implementation of more stringent testing standards, each process is strictly controlled, with high-end quality to win customers, with the ultimate service to gain reputation.

As the company continues to expand investment in research and

development, the product line will continue to enrich and expand, create high-level household aesthetics with high-end hardware, and create high-quality and high-grade life experience for families around the world.

Since its launch, SEZAO has been deeply concerned and favored by new and old customers. At present, it has developed many agents throughout the country, and its products are selling to all over the country and many overseas markets. SEZAO global investment is hot, welcome to join and create a better future.

思造 SEZAO®
高端家居五金



• T52- 场景

• T52- 罗马金拉丝



• A29-536 黑钢单色

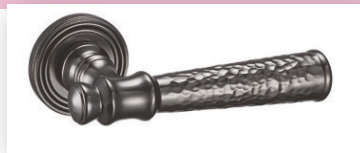

• SEZAO Ultra-thin Cube Drawer Series Product Picture



• Scene Picture Of SEZAO Ultra-thin Cube Drawer Series

Official Website:
www.vste-lock.com

Facebook:
Victor Vaisite

Instagram:
Victor Vaisite

E-mail:
www.vste-lock.com

WeChat:
威思特锁业

WhatsApp:
+86 18967730680

Official Website:
www.gdhegu.com

Xiaohongshu:
思造 高端五金官方号

Douyin:
思造SEZAO精工五金官方号

WeChat:
思造SEZAO高端五金官方号

Weibo:
思造高端五金官方号

E-mail:
GD_HEGU@163.com

Zhihu:
思造SEZAO

Kuaishou:
思造SEZAO 高端五金

WeChat Channel:
思造高端五金官方号

Bilibili:
思造高端五金官方账号



DMI specializes in development and innovative furniture hardware, guided by the philosophy of "Simple Design, Smart Living." We elevate home experiences through precision engineering, embedding technology seamlessly into daily life for effortless comfort.

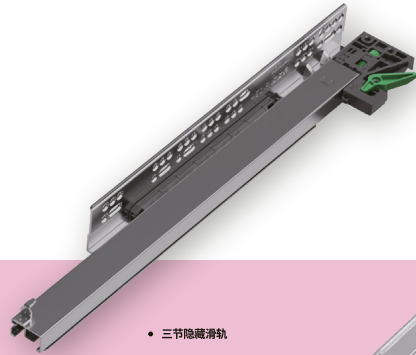

• 三节隐藏滑轨

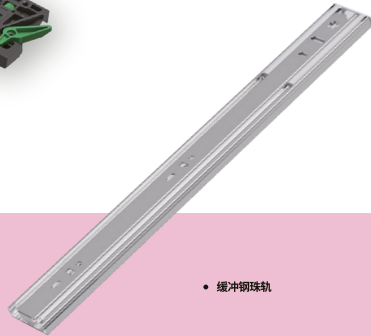

• 缓冲钢珠轨

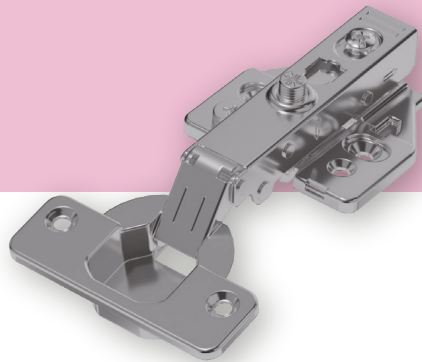

• 三维液压铰链

Email:
jason@jylalale.com



KANGYALE was founded in 2014, is a research and development, design, production and sales of smart home customization system of high-tech enterprises.



• Smart clothe lift



• Smart lift basket



• Smart window shutter

Official Website:
WWW.KANGYALE.COM

Tel & WeChat:
15813364172

Email:
kangyale2014@kangyale.com



Lusterful Science and Technology Ltd. is dedicated to the development, design, production and distribution of hardware products for several years. We're the high innovation enterprise for the overall solutions of furniture hardware accessories. Our main products include Concealed connector series, Metal cover connector series, Grille plate and Concealed Filler Panel Connector series, Suspension cabinet fitting series, Wall panel and Background wall connector series and Office locks products, etc. We spend all enthusiasm to achieve our ambition: producing outstanding products through our painstaking efforts.

Our company owns more than 60,000 square meters of factory buildings. We cooperate with Superb techniques in design, manufacture and quality management. We persist in the management policy of "quality of a reputation" and the business rationale of "people-oriented". Our company applies ISO9001 quality management system for series of products, aiming to provide the best user experience for you. Beside this, our multilevel pricing and excellent services help us earn a good reputation around the world, making our products stand out from the current competitive hardware market.



• Concealed filler panel connector



• Concealed filler panel connector



• Concealed Connector



• 场景图 - 书柜



Guangdong YISHIDA Hardware Precision Manufacturing Co., Ltd. Founded in 2000 and headquartered in Zhaoqing City, Guangdong Province - a strategic logistics hub, E-Star has dedicated over two decades to advancing precision hardware manufacturing. Operating a 15,000m² core production base within a 35,000m² Industry 3.0 automated smart factory, we implement cutting-edge production systems to ensure manufacturing excellence.

In 2011, we launched the "YISHIDA" hardware brand, specializing in R&D and innovation of multi-functional hydraulic hinges. Our proprietary Engineering Technology Research Center houses a professional R&D team that drives technological breakthroughs through intelligent design solutions and rigorous quality control protocols.



• S 型三维液压暗藏合页 3D hydraulic hidden hinge



• S 型三维液压暗藏合页 3D hydraulic hidden hinge

Weibo:
广东乐思富科技有限公司

E-mail:
lusterful@lusterful.cn

WhatsApp:
0086 15914353784

Instagram:
https://www.instagram.com/lusterful_china/

WeChat:
广东乐思富科技有限公司

Douyin:
广东乐思富科技有限公司

WeChat:
zhengliwujin

Instagram:
hydraulic_door_hinge

Facebook:
yishida001

Douyin:
YISHIDA888

WhatsApp:
13822635721

E-mail:
michelle@yishidahardware.com

Official Website:
www.yishida.vip



OUKEN Hardware Factory is a professional manufacturer of various high-end door handles. We are partners in high-end exhibition centers and hotel decoration. Our door handles are mainly made of high-quality materials, such as copper, brass, stainless steel, aluminum, solid wood, crystal, mosaic, and other raw materials. With superior craftsmanship and diverse material options, we deliver personalized, high-quality door handle solutions to global clients.

Ouken upholds the business attitude of integrity, pragmatism and foresight, pursues excellence, dares to innovate, provides customers with all round and high-quality supporting services, puts the interests of customers first, and truly establishes a long-term, stable, mutually beneficial and comprehensive cooperative relationship with customers!

• Ok-A384



• Ok-A388



Zhaotie specializes in the research and development of door&wall construction methods, as well as the production of indoor door products. It is a top professional hardware supply chain brand in the vertical field of door&wall system solutions in China. Founded in 1999 and began focusing on the field of interior doors in 2014. The service centers built in the form of urban partners cover major cities in China. After 26 years of accumulation and precipitation, already have over 60 invention patents for innovations in door-wall system solutions and fundamental construction techniques, including space rectification, leveling, and finishing. Zhaotie committed to original design, impresses consumers with good products, and takes the mission of creating a beautiful and comfortable living environment as its corporate mission, providing systematic solutions for perfect implementation.



• DOOR Series, Door and wall decorative surface door



• YISHU Series, Door and wall Paint concealed frame door

Official Website:
<http://www.oukenhardware.com>

Email:
oukenhardware@aliyun.com

Facebook:
[oukenhardware](https://www.facebook.com/oukenhardware)

Instagram:
[oukenhardware](https://www.instagram.com/oukenhardware)

Douyin:
1263354105

WhatsApp:
+86 18929849401

Official Website:
<https://www.ironplus.com.cn/>

Email:
xuxinyu@zhaotiejiaju.com

WhatsApp:
17706837178

Xiaohongshu:
[ironplus001](https://www.xiaohongshu.com/profile-detail/ironplus001)



RUNCHUNG

Runchung Decoration Materials Co., Ltd. is a leading enterprise focusing on the production and sales of edge banding. It was established in 2009 and is located in Nangang Industrial Zone, Zhengding County, Shijiazhuang City, Hebei Province. It covers an area of about 21,000 square meters, including 8 granulation production lines, 40 extrusion production lines, and 16 printing production lines. The company adheres to the core concepts of

innovation, environmental protection, and high cost performance, and is committed to providing customers with high-quality edge banding products and all-round solutions. Products include PVC edge banding, ABS edge banding, customized edge banding, etc. Runchung has advanced production equipment and a strict quality control system. All products have passed national physical and chemical testing and international quality standard certification.



• 产品 ABS 单色



• 产品 PVC 木纹



Since the establishment in 1999 in Hong Kong, Sunny Fund Enterprise Ltd has built a global supply chain in the wood industry. We have combined work experience of over 25 years in the production of wood products including hardwood timber logs, wood veneer, OSB & FOSB panels. With the quality raw materials, most advanced equipment and experienced processing skills, we focus on providing consistently high quality products to our customers. Guangxi Elegant Face Wood Co., Ltd., a subsidiary of Sunny Fund, is committed to R&D, production and sales of OSB and FOSB products.

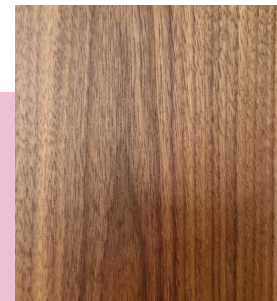

• 黑胡桃木皮 Walnut Veneer



• OSB



• 白橡木皮 White Oak Veneer



• FOSB

Official Website:
www.runchung.com

Wechat:
+86 150 9732 6961

Email:
amy@runchung.com

Official Website:
WWW.SUNNYFUNDWOOD.COM
WWW.FACE-BEST.COM

E-mail:
sunnyfundwood@hotmail.com
inbox_gxphusan@hotmail.com

Wechat:
非常面子木业



Dongguan Huali Industrial Co., Ltd. (abbreviated as Huali Stock, stock code: 603038.SH), established in 1995, was listed on the main board of the Shanghai Stock Exchange in 2017. Starting from the decorative composite materials sector, the company has adhered to principled innovation and upheld the spirit of craftsmanship over three decades. It has evolved into a comprehensive holding enterprise encompassing four major business domains: home building materials, smart water services, membrane filtration materials, and industrial digitalization and intelligentization.

The home materials division primarily produces edge banding and decorative panels, mainly used for panel furniture, interior decoration, and commercial space design. As a pioneer with independent intellectual property rights in edge banding manufacturing, Huali Stock has played a leading role in formulating critical industry standards for edge banding in China. Renowned for its R&D capabilities and innovative strengths that rank among the industry's forefront, the company delivers professional design solutions and high-quality home materials globally. Its production bases are strategically located in Dongguan, Foshan, Jiaying, Chengdu, Huanggang, and Wuhu.



• 华富立饰板 Hualuli Decorative Panel

• 华富立饰板 Hualuli Decorative Panel2



Official Website:
www.opksliding.com

E-mail:
opk@opk.cc
chryso@opk.cc

WeChat:
华富立装饰材料

WeChat Channel:
华立装饰材料

Douyin:
华富立饰板

Xiaohongshu:
华富立饰板

Official Website:
www.dekekc.com

Email:
dk_susan@dekekc.com

Douyin:
Dekek德科康

WeChat Channels:
Dekek德科康

Weibo:
Dekek德科康

Dekek 德科康

Dekek Group Founded in 2017, Dekek Group is a wood-based panel group integrating R&D, production and sales, one of the leading manufacturers of OSB in China, basing on high-tech automated manufacturing with the world's leading equipment, such as DIEFFENBACHER continuous flat pressing system and KADANT knife shaft flaker. Its headquarter is located in Guangxi, that has built smart factories with fully automated production in Fusui County, Chongzuo City and Bobai County, Yulin City, respectively, with a total annual production capacity of about 1 million m³.

Dekek FOSB has the characteristics of moisture resistance, flame retardancy, deformation resistance, and formaldehyde-free. It can be pasted with melamine, veneer, PET, PETG and other finishes, and can also be directly sprayed coat, polytetrafluoroethylene, ultraviolet rays, electron beam curing, etc.



• FOSB3 香杉 & FOSB3 Chinese fir



• 德科康饰板 & FOSB CHUN



• OSB



Guangxi Yijiamei Wood-based Panel Co., Ltd. was established in 2021. It is an innovative high-tech enterprise specializing in the research and development of high-end particle boards, with an annual output of 500,000 CBM of OSB (oriented strand board)/FOSB (Fine surface oriented strand board)/SPB (particleboard with MOR more than 18MPa). Yijiamei is located in the hometown of largest eucalyptus, fir, pine and other wood industry base, Guangxi-Guizhong Wood Products Technology Industrial Park, covering 280,000 square meters.

The company is equipped with the European Industry 4.0 generation of highly automated CPS+ continuous pressing OSB/FOSB/SPB production lines from Diefenbacher, Germany. The main equipment comes from Canadian KADANT; German MAIER two-section chipper, chipper and grinder machine; Italian IMAL PAL dry shavings super screen; German DIEFFENBACHER super atomized drum glue mixer, glue adjustment system, 5-head multi-function paving machine, CPS with cooling section + continuous hot press; German GreCon online thickness detection system, Bubble detection system, automatic spark detection and extinguishing system; Swiss STEINEMANN sander; Austrian Schelling intelligent sawing system.



• 定向刨花板 OSB



• 可饰面刨花板 FOSB



• 防潮板_Moistureproof board



• 镀锌板_After processing board

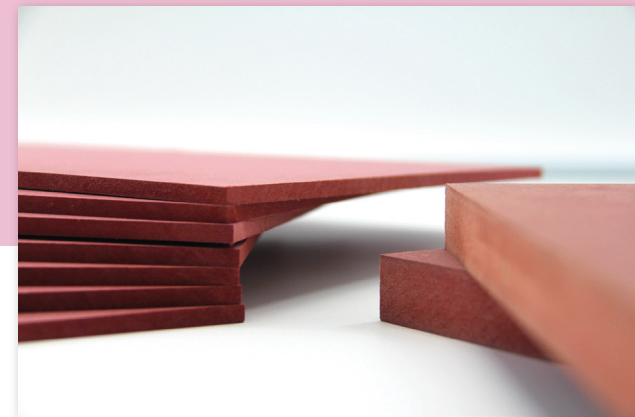

• 阻燃板_Flame retardant board



Guangxi Sunway Wood-Tech Co., Ltd. is an industrial company specializing in the research, development, and production of high-end eco-friendly wood-based panels and resins. With a registered capital of 414 million yuan, it has six wholly-owned subsidiaries and five production bases across Guangxi, with an annual capacity exceeding 1.6 million cubic meters. The company has been honored as a National Key Forestry Enterprise and a National Green Factory. In the future, it will uphold the concept of green development, promote precision manufacturing, strengthen scientific innovation and brand advantages, and strive to build a major domestic wood-based panel production base and a leading manufacturing center in Asia.



WeChat:
+86 15853088215

WhatsApp:
+86 15853088215

Official Website:
<http://www.3sunway.com>

E-mail:
susee2006@163.com
candyzhong@vip.sina.com

WhatsApp:
+86 15007748118
+86 13788049803

WeChat:
15007748118
13788049803
13977482001



Guangdong xin chuang new material technology Co., Ltd. is one of the subsidiaries of Zhihua Group, since it set up we has been a diversified production and sales enterprise focusing on the boards' decorative material, and decorative boards.

We own the first high-end production equipment in Asia which jointly developed by Zhihua Group and European SML, and we own the first domestic EB (electron beam) curing equipment, and the first use the civilian nuclear technology to the decorative materials, we have the automon pur

lamiante machine line, free dusty worksops, automon UV production line, Excimer technology equipment production line, 7*9 and 4*9 Wemhöner hot press machine. At the same time, we have a professional technical research and development team and a senior production team to achieve building materials innovation, industry integration and multi-dimensional presentation, bringing a revolutionary experience to the building materials industry.

Main products : High-end decorative petg film, petg sheets and films, EB film, EB sheet, acrylic sheet, UV board, PET MDF board, EB board, acrylic board, EB texture board and matching color seal edge bar ,which with high gloss and super matte unique metallic finish and solid color finish.



• EBT-2301 玛尔塔胡桃



• EBT-2302 玛尔塔胡桃



• EBT-2303 玛尔塔胡桃



D区 Area D

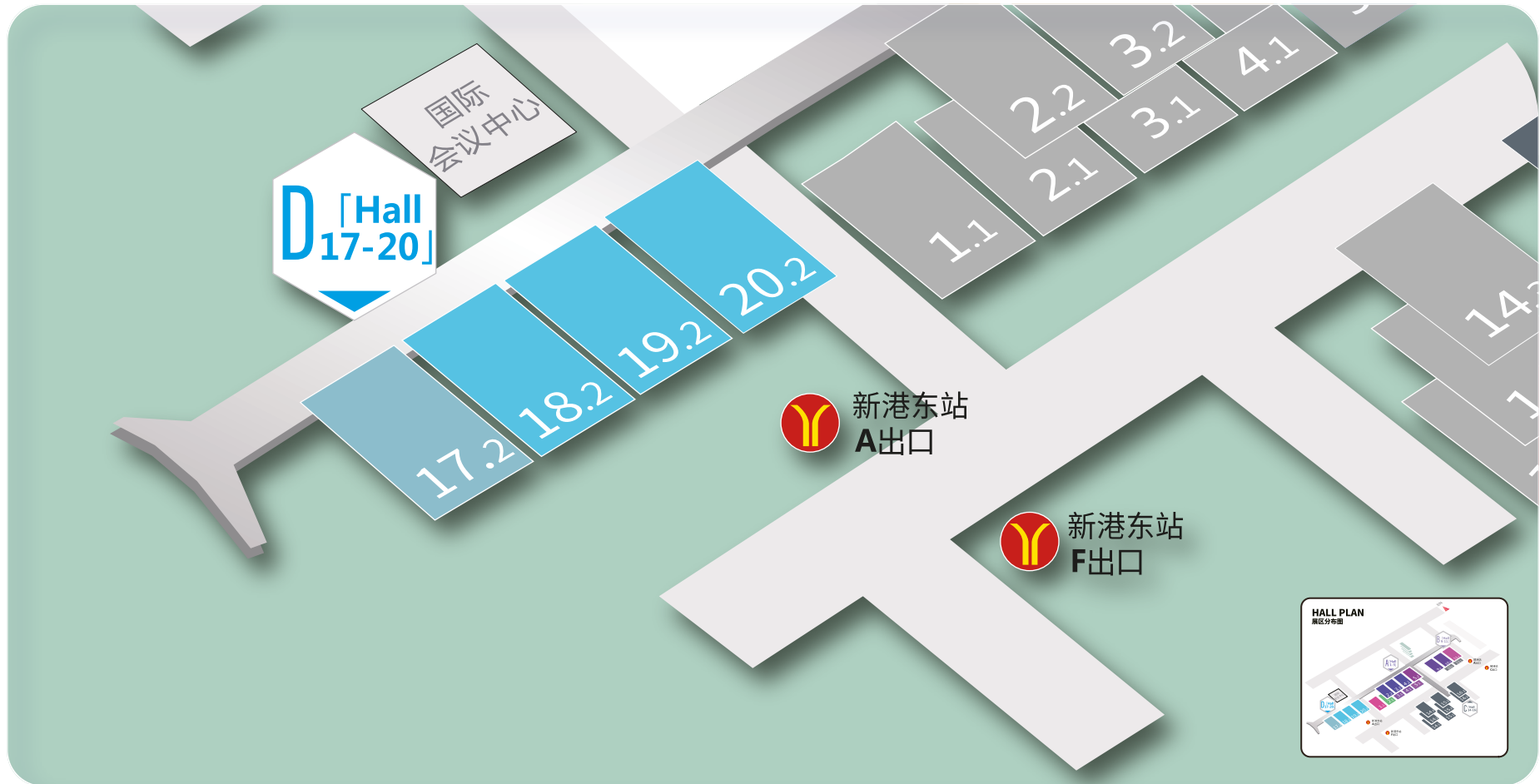

17.2

ENTRANCE DOOR/PATIO SHADING/
DOOR & WINDOW HARDWARE & ACCESSORIES
入户门/庭院遮阳/门窗供应链

18.2-20.2

SYSTEMATIC DOOR & WINDOW/
DOOR & WINDOW HARDWARE & ACCESSORIES
系统门窗/门窗供应链



Foshan City Shunde Yili New Material Technology Co., Ltd. was founded in 2013. We have focused on supplying high-quality special powder which to be applied on the surface of entry door, aluminum products, steel products and other industries, and won customers' praise and trust with high-quality products and services. In 2024, with outstanding performance in technology, products, and markets, it won the title of "high-tech Enterprise".

In the future, we will adhere to the purpose of service, improve the level of technology and service, increase research and development, launch more leading products, optimize the service process, and bring more high-quality and convenient service experience to customers.

Yili looks forward to working with friends from all around the world to jointly create a better future of special powder industry!



• 超耐候平面系列 Super Weather-resistant Flat Metal Powder Series

• 超耐候砂纹系列 Super Weather-Resistant Sand Texture Series



MIQI 米祺角码
— 注胶角码缔造者 —

We are a service provider that has long been committed to the research and development of corner connections for system doors and windows. We specialize in providing corner connection solutions for system doors and windows. Our company is located in Foshan, Guangdong, China.

Our main products include Die - cast Expansion Connectors, Die - cast Connectors, High - precision One - piece Glue - injection Corner Codes, One - piece Center Columns, Die - cast Glue - injection Connecting Pieces, Drain Pipe Connectors, etc. Our business covers a wide range of fields, including various aluminum die - castings.

The company is equipped with advanced production equipment and technology and has strong R & D and production capabilities, and is able to customize high - quality products according to customer requirements.

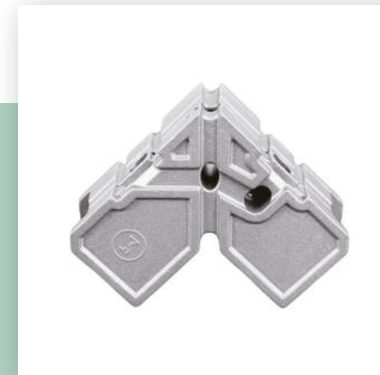

• Door and Window Corner Connector



• Die - cast Glue - injection Connecting Piece



Huajian Aluminum was founded in 2000 and is located in Linqu, Shandong, the capital of China's aluminum industry and the capital of China's doors and windows. It is a large enterprise group mainly engaged in aluminum profile production and aluminum deep processing industries, with coordinated development of related industries and a complete industrial chain. It has six production plants, six industrial parks, and three service platforms of "exhibition, testing, and hotel". Eos System Windows and

Doors is an exclusive integrated processing center of Eos System Windows and Doors under Huajian Aluminum Group. The company is located in Zone C of the Sino-European Energy-saving Windows and Doors Industrial Park in Linqu, Shandong. purchased imported Amei Bestar automated processing equipment, and used the Belgian JOPPS design software to generate standardized process data for the Eos System Windows and Doors system, driving the sawing center, CNC processing center and other equipment for online production, achieving an annual production capacity of 300,000 square meters of high-end energy-saving system windows and doors.

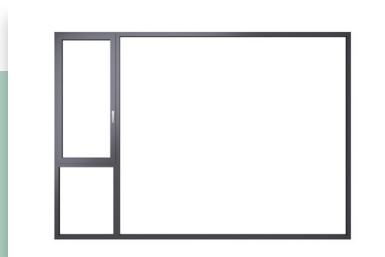

• EC080

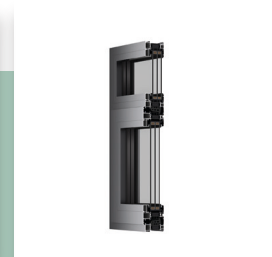

• EC080



• EC080 场景



Deep Comfort, Inspired Living

PAIYA Windows & Façades is a benchmark brand in China's aluminum door and window systems industry, with 35 years of dedicated expertise in research, development, and manufacturing. In 2013, PAIYA became the founding Chair of the Guangdong Aluminum Door & Window Committee and was elected Chair of the Provincial Door Industry Association in 2022. Recognized as a National High-Tech Enterprise and Industry Technology Pioneer, PAIYA continues to lead with innovation and integrity.

Featured for four consecutive years on CCTV's The Growing of a Great Brand, PAIYA launched its groundbreaking "Deep Comfort" design philosophy in 2023—redefining standards in thermal performance, safety, and human-centric design. In 2025, with the rollout of Premium Strategy 4.0, PAIYA achieved No.1 nationwide in high-end door and window sales for three consecutive years. Having served over 10 million households globally, PAIYA integrates smart manufacturing with cutting-edge technology to drive consistent breakthroughs in comfort, security, and architectural aesthetics. As a champion of Chinese craftsmanship on the global stage, PAIYA is accelerating the evolution of modern living and elevating the international reputation of China's fenestration industry.



• 绘景断桥平移挤压窗



• 万家灯火口袋门(埋入式吊轨)



• 旭日 85 内开窗

Official Website:
www.huajian-al.com

E-mail:
sales@huajian-al.com

WeChat:
山东华建铝业集团

Kuaishou:
hjljv001

TikTok型材:huajian.aluminum
TikTok型材新号:huajian.aluminum.f

TikTok护栏账号:hualv.aluminum.g

TikTok光伏支架账号:sweeneyfarish

TikTok门窗账号:aluminum.door.an

TikTok模板脚手架账号:huajian.aluminum0

INS:huajianaluminum

YouTube:HUAJIANALUMINIUM-sz3ni

Official Website:
www.paiya.com
www.paiyaworld.com

Email:
Loy@paiya.com

Facebook:
Paiya Door&Window

WhatsApp:
+86 18927757125

WeChat&WeChat Channel:
派雅门窗官方

Douyin:
派雅门窗

Xiaohongshu:
PAIYA派雅门窗

Weibo:
派雅门窗



FREER Doors & Windows Co.,Ltd. — A modern enterprise committed to providing high-end aluminum alloy door and window solutions to global consumers. specializing in high-end customized aluminum alloy windows for 45 years. As the first brand to deeply link windows and doors with regional climates, We provide personalized solutions based on different climates around the world. Our products include indoor systems, building facade systems, and outdoor systems, delivering world-class windows and doors that are safe, durable, and energy-efficient.



• 节能王 J30 平开窗 - 书房

• 节能王 J30 跃层平开窗 - 外立面



Since its founding in 2012 by the name of "Guardian", WARREN has built 150,000 square meters of intelligent R&D and exhibition bases in Beijing, Shandong, and Guangdong with a national standard testing center. We have invested heavily in the introduction of 6 German Elumatec Automatic Processing lines to make the manufacturing more precise and effective. Our products have passed CE, AAMA, NFRC, NAFS, Intertek, NAMI CSA Certificates. The annual output can reach over 1 million square meters. Meanwhile, Warren also exported Chinese smart products overseas, occupying the high ground of export trade.

In 2021, Warren collaborated with designer Weiyan Shao to create a new China chic space, infusing doors and windows with new vitality through color. At present, Warren has over 450 Warren Stores in China, "guarding" every moment of quality life with high.



• 星享 75 拼接内开窗



• 星欧 75 内开窗



• 星享 75 平齐内开窗

Official Website:
<https://www.freeri.com.cn>

E-mail:
jjabuer183@gmail.com

WhatsApp:
+86 18884271937

Mobile:
+86 18328406044
Du Jan (Business Manager)

Official Website:
<https://www.wolunmc.com/>

Email:
Info@wolunmc.com



Douyin:
沃伦系统门窗

WeChat:
沃伦系统门窗

Xiaohongshu:
沃伦系统门窗

Weibo:
沃伦系统门窗



Jiangxi Fenfa Group Co., Ltd. is located in Anyi Industrial Park, Nanchang City, along the Changjiu Economic Belt. It covers an area of 180 mu and has 80,000 square meters of modern standard factory buildings. It has now developed into the largest R & D and production center for construction silicone sealants, sealing strips, and door and window hardware accessories in the country, and is the first "one - stop" supplier of door, window, and curtain wall accessories in China.

Fenfa Group is among the top 500 building materials enterprises in China, one of the top 100 most growth - oriented building materials enterprises in China, and one of the top ten brands of door, window, and curtain wall hardware in China. It is a designated production enterprise for building door, window, and curtain wall accessories in China, and an approved enterprise for the production of silicone structural sealants for construction.



FS5000

Silicone Weatherproof Sealant

Storage and shelf life
Non-dangerous product, should be stored in a dry and shady place, temperature 4°C-27°C

Colors
Black, white, grey, transparent or customer require

Packaging
590 ml/sausage

Standard
JC/T 982-2001

Feature

- One component, easy to use and has good thixotropic extrusion
- Neutral curing, suitable for most building materials without adverse reactions
- For normal stretching and shear deformation, the performance remains unchanged after the curing, elastomer forms can fit load interface a 35% displacement ability.
- Excellent weatherability, service life more than 30 years.
- Excellent cohesiveness with the vast majority of construction materials.
- Good compatibility with other neutral silicone adhesives.

Application

All kinds of glass curtain wall weather resistant sealing

Joint sealing of roof construction

Weather proof sealing of metal and aluminum plastic panel of concrete, plastic panel-metal

Joint sealing of concrete, plastic and metal

Other uses

The following conditions can't be used or constructed

- Material surface temperature below 4°C or over 40°C
- Paint surface, maybe due to paint peeling or oxidizing lead to adhesive failure.
- Structural bond sealing of curtain wall engineering
- Dew or wet surfaces, continuous soaking place or wet places throughout the years.
- All materials that ooze grease, plasticizers or solvents, and vulcanized or partially vulcanized rubber lining tapes without airtight places.

• FS5000



Guangzhou newhoo technology co.,ltd. was founded in 2015, is a focus on outdoor shading materials And finished products of the enterprise. The company is located in Hongyu Zhihui Industrial Park, 16KM north of Guangzhou Baiyun Airport, Daguang, Pearl River Delta Ring Line, Leguang and other highways intersection, the company has 10,000 square meters of modern factory buildings. NEWHOO technology focus on outdoor sunshade products, with more than 20 years of industry experience in R & D, production team. We hold 118 patents for outdoor sunshades and related products. Independent intellectual property rights, products are well known to the industry, exported to Europe, America, Australia, Southeast Asia and other regions. NEWHOO Technology based on its own intellectual property products, a wide range of ODM, OEM and other services.



• WR120 Windproof Roller Blinds



• WR120 Windproof Roller Blinds



• WR150-220 超宽双层防风卷帘系统

Official Website:
<https://www.fenfagroup.com>

Email:
xuxudong123@gmail.com



wechat

Official Website:
www.gznewhoo.com
<http://www.newhoosunshade.com/>

Email:
sales@gznewhoo.com

ISI HENNISSY

Hennissy Doors and Windows, started business in 2004, is an innovative enterprise that focuses on high-end system doors and windows customization, integrating R&D, manufacturing, sales and services, with a total production area of more than 300,000 square meters. In the international market, Hennissy Doors and Windows has overseas bases in Australia, Thailand, the United Arab Emirates, and other countries. Its business covers six continents around the world, achieving extensive coverage of the global market.

For 21 years, Hennissy Doors and Windows has focused on the construction of the value of human living space, aiming to create world-class environmentally friendly system doors and windows, and provide end consumers with a one-stop five-star service experience. Its main products include aluminum alloy doors, aluminum alloy windows, sun rooms, curtain walls, ecological doors, entrance doors, bathroom partitions, fully furnished balconies, etc., providing standard professional and meticulous services to hundreds of millions of consumers around the world.



• AC100-casement-window

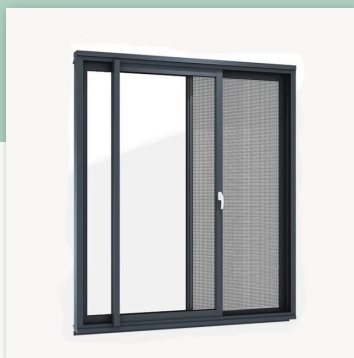

• AC100 sliding window

SIMBOR

The Simbor Doors and Windows was founded in 1999, focusing on curtain wall doors and windows, aluminum wood doors, entrance doors, and high-standard customization. Our products are applied to high-class home decoration, hotels, clubs, villas, etc. We are a professional supplier of high-class home system doors and windows services and provide high-end home system customization services to 200000 households every year.

Relying on years of technological research and development iteration, Simbor Doors and Windows has pioneered the era of doors and windows 5.0, creating a new category of panoramic curtain wall windows, and ushering in a new era of systematic doors and windows in China. Adhering to the creation attitude of "German precision, Italian design, and Eastern craftsmanship", the Simbor doors and windows continue to strengthen and advance, and have obtained more than 100 national patents, comprehensively leading the development of this industry.



Official Website:
<https://thwindows.en.alibaba.com>

Youtube:
<https://www.youtube.com/channel/UC5CenH7jHb30vg8-C4N-z-g>

E-mail:
hennissy.net@gmail.com

WhatsApp:
+86 13341318451
+86 18138332296



Official Website:
www.cnsimbor.com

Email:
info@cnsimbor.com

WeChat:
新标门窗

WeChat Channel:
CNSIMBOR

Facebook:
Simbor window and door



Edun is headquartered in Foshan, Guangdong. It has showroom center, digital production center and an international marketing center. The modern intelligent manufacturing factory covers an area of 300,000 square meters. It is a comprehensive door and window enterprise specializing in the research and development, design, production, sales and service of high-end aluminum alloy system doors and windows for the whole house. The company's products cover sliding doors and windows, casement doors and windows, curtain walls, sun rooms, entrance doors, ecological doors and other series. It is an advocate brand of Chinese security system doors and windows.



• 77 TYPE BI-FOLD DOORS

Key-point is a technology-based enterprise integrating manufacturing and service of curtain wall and door & window hardware, etc. We provide architectural hardware and related technical consulting.



In-depth exploration of the development trend of architectural hardware in the future, to create build quality life art space.

Focus on the development concepts of safety, energy saving and eco-friendly in the doors, windows and curtain wall industry.

Continuously pushing forward with humanised design as the base to meet the users' pursuit of quality of life.

Gently resonate the architectural space with life, meaning to make the space and the environment harmoniously blend into one.



• JNPX100PKZ





Founded in 1990, Guangdong Fenglu Aluminium Co., Ltd., is a leading aluminium extruder in China.

We've established a complete aluminum processing industrial chain encompassing mold design and manufacturing, R&D, alloy melting, surface treatments to "high-end, precision, and advanced" processing technologies, along with a comprehensive production and operation management system, equipped with various tonnages

of presses including 20,000T, 10,000T, 7,500T, among others, as well as anodizing and powder coating production lines.

We have successively obtained various certifications, including ISO9001/14001/18001, IATF 16949, IRIS, Qualicoat/Qualanod, TÜV, and DNV...etc. In 2025, Fenglu Aluminum's new production base went into operation, this fully integrated, automated, and intelligent production base spanning the entire industry chain will establish a new benchmark for intelligent manufacturing in China's aluminum extrusion industry. Moving forward, Fenglu will continue to lead the industry's transformation and upgrading, striving for sustainable development while pursuing its vision to become a globally influential enterprise in aluminum extrusion R&D, manufacturing, and service provision.



• GD120C Series Tilt & Turn Casement Window



• Series Six-Track Sliding Window

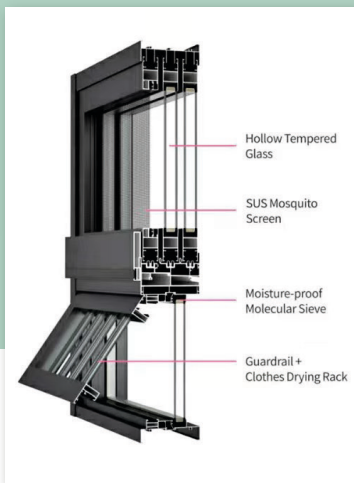

• Series Six-Track Sliding Window



Forge Window, established in 2001, specializes in the integration of R&D, manufacturing, marketing, and services for high-end system doors and windows. With three production bases spanning over 200,000 square meters in Foshan, Shandong, and Shaanxi, the company operates more than 600 brand flagship stores and over 1,000 offline service outlets nationwide. Its products are exported to over 100 countries across North America, Southeast Asia, the Middle East, and beyond.

With over two decades of development, Forge Window has built a robust professional technical R&D team, supported by dedicated facilities including a systematic doors & windows technology application center, an R&D and testing base for doors and windows. The company holds dozens of patent certificates and has obtained both ISO 9001 International Quality Management System Certification and Australian Standard Certification. Committed to delivering premium products and professional technical services, Forge Window continues to lead innovation in the industry.



• FGH150

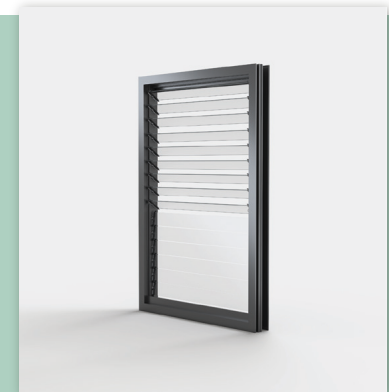

• 手动百叶 - 单品



• FGH150 手摇外开上悬窗

Official Website:
www.fenglualu.com

E-mail:
company@fenglu-alu.com



WECHAT

Official Website:
<https://www.forgewindow.com/>

Email:
rich@forgewindow.com

Douyin:
富贵花门窗总部号

WeChat Channel:
富贵花门窗总部号

Xiaohongshu:
富贵花门窗总部号

WeChat:
富贵花门窗

Facebook:
富贵花门窗
Golden Flowers Jin

Instagram:
FORGE WINDOW

WhatsApp:
+8615627276356

TikTok:
china windows doors
china windows doors3

新豪轩门窗 SUNHOHI

Founded in 2003, Sunhoi Smart Home Co., Ltd is a Guinness World Record holder. As a modern large-scale enterprise that integrates research and development, design, production of windows and doors. Our products include aluminum windows and doors, interior wooden doors, entrance doors, shower rooms, sunrooms, skylights, window wall and curtain walls. Sunhoi operates a 350,000 square meter green intelligent manufacturing base with annual production capacity exceeding 1.5 million square meters. With a domestic and oversea marketing network of over 1,100 flagship stores, the company provides clients with comprehensive customized solutions featuring safety, soundproofing, energy efficiency, and environmental sustainability.



• IDEA05 吊趟门 IDEA05 Overhead Sliding Door



• IDEA25 全景推拉窗 IDEA25 Panoramic Sliding Window

TECHNOFORM 泰诺风

Founded in Kassel, Germany in 1969, Technoform Group is a world-renowned manufacturer and supplier of thermoplastics and precision profiles. As a global supplier of building insulation materials, we always look for the perfect solution for you. This spans from thermal edge bond solutions for architects, building planners, and manufacturers, and manufacturers of insulating glass units (IGUs), a vast range of insulation solutions for aluminum windows, doors, and facades, to high-precision plastic profile solutions and system components for the automotive, aviation, and electrical engineering industries-just to name a few. 45 sites in over 40 countries ensure continuous supply wherever you are.

Technoform established production plants in Suzhou and Hong Kong in 2001 and 2009 respectively. As a pioneer in the development of insulation profiles, we always continue our search for optimized and tailored solutions. Thus, we guarantee you to find the best possible result for every challenge. and we in European Standard and Chinese Standard Professionalism leads to success! With our rich technical experience accumulated in Europe for the past 50 years, Technoform is looking forward to working with our friends and partners in the building industry around the world to create energy saving, sustainable, high quality and elegant thermally broken windows, doors and facades of the future.

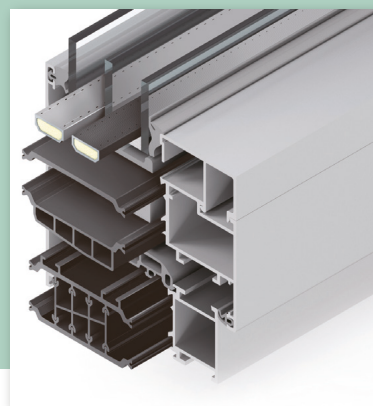

• Technoform Thermal insulating strip



• Technoform Thermal insulating strip





ROLANSINI

Founded in 2008, Rolansini specializes in the design and production of high-quality aluminum window and door systems. As a trusted name in the industry, we cater to a diverse clientele including developers, builders, contractors, architect, distributor and homeowners. Our commitment is to design bespoke and premium solutions tailored to meet the specific performance requirements and budget constraints of various markets.

We engineer our products to offer superior insulation against dust, rain, pollution, and noise, ensuring comfort and protection for your space. Additionally, Rolansini provides comprehensive installation guidance and services to ensure satisfaction with every project. Join us, and experience excellence in every detail.



• R3



• T9



OPK Smart Home Technology Co.,Ltd was founded in 1996 and headquartered in the well-known hardware products base-Xiaolan Town, Zhongshan City of China. OPK mainly develop, produce and sell all series of household furniture sliding industry. By now, the core products include furniture soft closing sliding system, hollow door soft closing sliding system, wooden door decoration engineering soft closing sliding system, Shower room soft closing sliding mechanism and heavy door soft closing sliding system.

OPK is always dedicated to the development of household furniture sliding industry, and with professional technology and devoted attitude, OPK has achieved hundreds of patents, and realized large scale production, product seriation and management modernization. OPK established OPK Brand and Roller Institute, in which powerful R&D team acted as the core. Set up Industry Academia Research and Graduate Workstation. Found Branch Company in Germany and integrated into Europe and America high-end marketing.



• opk E-Space

• FURNITURE POCKET DOOR SYSTEM

• opk Perfect slim system



Official Website:
www.rolansini-windows.com

Facebook:
<https://www.facebook.com/rolansiniwindow/>

Douyin:
罗兰西尼系统门窗

Xiaohongshu:
罗兰西尼系统门窗

Email:
marketing001@rolansini.com

Pinterest:
https://www.pinterest.com/Rolansini_window/

WeChat:
罗兰西尼门窗

Weibo:
罗兰西尼系统门窗

Youtube:
https://www.youtube.com/@Rolansini_window

Official Website:
www.opksliding.com

Wechat:
opk欧派克滑轮

E-mail:
opk@opk.cc
chryso@opk.cc



ROHIL 融海

Ronghai (ROHIL) New Materials Company has 8 branches globally, namely Fujian Ronghai New Materials Technology Co., Ltd., Fujian Delike Auto Parts Co., Ltd., Zhangzhou Ronghai Polymer Materials Co., Ltd., Foshan Ronghai Production Base, Zhangzhou Ronghai Rubber and Plastic Technology Co., Ltd., Zhangzhou Ronghai Medical Supplies Co., Ltd. (ROHILMEDICAL), Shantou Yongwang New Materials Technology Co., Ltd., and the Philippine San Simon Plastics Company. It owns 7 factories globally and has more than 45 sales offices, with services covering the whole world.

Fujian Ronghai New Materials Technology Co., Ltd. was established in 2003. In 2017, it was relocated from Huizhou, Guangdong Province to Zhao'an County, Zhangzhou City, Fujian Province. In August 2018, it was officially renamed Fujian Ronghai New Materials Technology Co., Ltd. with a registered capital of 25 million yuan. The company is located in the first phase of Zhao'an Industrial Park, Zhangzhou City, Fujian Province, covering an area of more than 40 mu, and the second phase covers an area of 330 mu. It mainly develops and produces PA66GF25 thermal break strips, nylon PA66, PA6 modified raw materials, sealing strips, auto parts, etc.



• 融海-202503-海报



• 融海-202503



viewmax® 极景®高性能门窗

ViewMax Windows and Doors Limited was established in 2014 and is a national high-tech enterprise. The's headquarters is located in Yanggu County, Shandong Province. It is a system window enterprise that integrates the production, research and development, and marketing of silent windows, windows, intelligent entrance doors, sliding doors, energy-saving curtain walls, and sunrooms. The company stabilizes product quality by integrating the supply chain and has independent processing workshops such PVC profile workshop and aluminum system workshop. Through the robot intelligent production line, the production efficiency and product quality are greatly improved. The company adopts technical means such as the ViewMax Cloud Platform to achieve personalized customization of windows and doors and batch flexible production. The company owns more than 140 invention and utility model patents. It has participated in the of several window and door industry standards. With a sincere, candid, professional, and responsible attitude, it has built an international and modern production line, giving users an extraordinary ultimate life.



• E3



• E3

E-mail:
rohil88@126.com

Tel:
18046156939

Official Website:
www.4001690009.com

Email:
1058586545@qq.com

Tel:
于凯 138 9523 8963

WeChat:
极景高性能门窗

Douyin:
极景高性能门窗

Kuaishou:
极景高性能门窗

Xiaohongshu:
极景高性能门窗



Henan CROWN Window & Door Co., Ltd. is a pioneering enterprise dedicated to green, energy-efficient building solutions, specializing in zero-carbon buildings, near-zero energy consumption systems, and passive ultra-low energy doors/windows. Integrating R&D, production, sales, installation, and industry chain development, CROWN champions sustainable construction innovation.

CROWN main products including ES65MD+, ES70MD+ low energy saving Windows, ES70MD+ barrier free silent door, ZEW80MD+ultra-low energy

passive window, ZEW92MD+ ultra-low energy passive window, SES210+ lifting sliding door, GEE180+ sun room, curtain wall and other products. CROWN provide Film coated and German environmental protection water paint surface treatment to meet the diverse needs of customers. With excellent products and excellent after-sales service, CROWN has won wide praise from first-line architectural designers and become the ideal choice for thousands of customers to build green and energy-saving buildings.



• ES81MD



• ES70MD



Business Service Guide

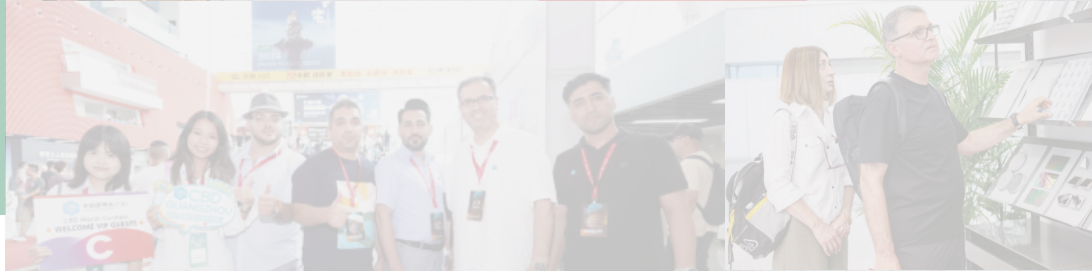

Official Website:
www.baydeegroup.com

Facebook:
Baydee UPVC Profile

Email:
info@hnbeidi.com

TikTok:
baydee_chn

TRANSPORTATION

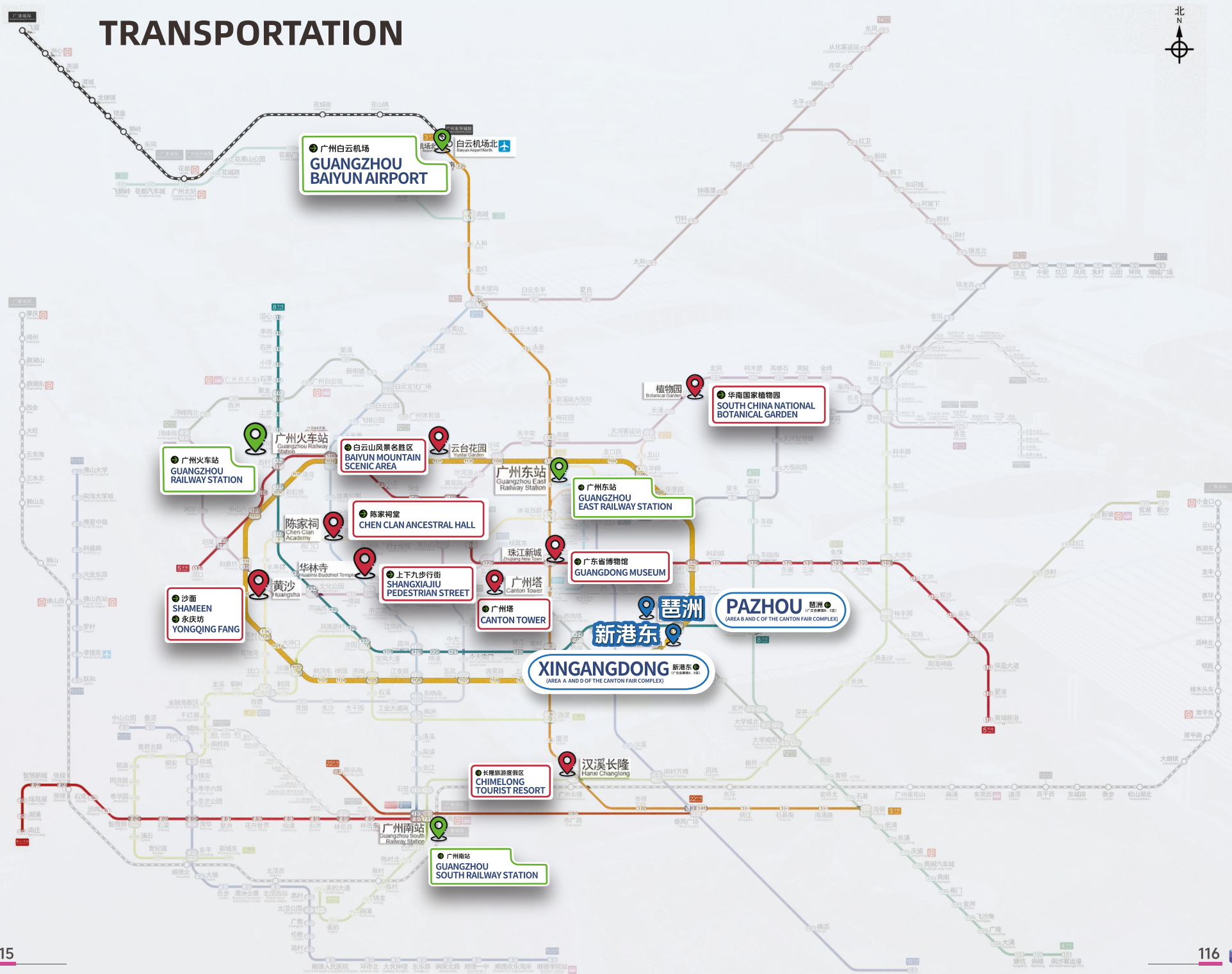

TRANSPORTATION

-BY METRO

EXIT A OF XINGANGDONG METRO STATION

Area A & D of the Canton Fair Complex

(NOTICE: AREA D ENTRANCE WITH INTERNATIONAL BUYERS SERVICE)

EXIT A OR B OF PAZHOU METRO STATION

Area B of the Canton Fair Complex

EXIT C OF PAZHOU METRO STATION

Area C of the Canton Fair Complex



-BY AIR

GUANGZHOU BAIYUN INTERNATIONAL AIRPORT TERMINAL 1/ TERMINAL 2

To Area D of Canton Fair Complex Nearly 30km



-BY WATERWAY PAZHOU FERRY TERMINAL

Cross-border travelers can directly check in and drop off their luggage for international airline flights departing from Hong Kong at the Pazhou Ferry Terminal, and enjoy the one-stop sea-to-sky transportation service of "Guangzhou check-in, Hong Kong boarding".

*Reach the official website for more details:

<https://www.cksp.com.hk/#/main/home>



-BY LAND ROUTE RAILWAY

There are 4 major transportation hubs in Guangzhou – Guangzhou Railway Station, Guangzhou East Railway Station, Guangzhou South Railway Station and Guangzhou Baiyun Railway Station, which connect almost every border city in Guangdong Province and most inland cities in China.



VIP QUICK ACCESS	★ REGISTRATION HALL, AREA D, GATE 6 WITH INTERNATIONAL BUYERS SERVICE
	HALL 5.1, AREA A
	AREA A, GATE 5
	NORTH SQUARE ENTRANCE, AREA A
	HALL 11.1, AREA B, GATE 4
	HALL 10.1, AREA B, GATE 4
	AREA C, GATE 10
	AREA C, GATE 9

BUFFET	Elite Club, Opposite to Hall 4.2, Area A
	Canton Fair Restaurant, Area B
BANK	OPPOSITE TO HALL 9.2, PEARL RIVER PROMENADE, AREA B
	NEAR HALL 2.1 AND 3.1, PEARL RIVER PROMENADE, AREA A
VIP LOUNGE	MEETING ROOM 1, OPPOSITE TO HALL 3.2, PEARL RIVER PROMENADE, AREA A
	ENTRANCE OF CENTRAL PLATFORM, AREA B
	HALL 16.2, AREA C
	MEETING ROOM V10, OPPOSITE TO HALL 20.1, PEARL RIVER PROMENADE, AREA D

INFO	OPPOSITE TO HALL 5.1, PEARL RIVER PROMENADE, AREA A
	OPPOSITE TO HALL 1.1, PEARL RIVER PROMENADE, AREA A
	NEXT TO HALL 11.2, PEARL RIVER PROMENADE, AREA B
	NEXT TO HALL 9.2, PEARL RIVER PROMENADE, AREA B
	CENTRAL PLATFORM, SECOND FLOOR, AREA C
	FIRST FLOOR, AREA C
	OPPOSITE TO HALL 20.1, PEARL RIVER PROMENADE, AREA D
	OPPOSITE TO HALL 17.1, PEARL RIVER PROMENADE, AREA D



A. 4 Days Offline Fair

- **All Top Brands Included**
Over 2,000 exhibitors.
- **A Variety of Activities**
Over 100 high-end conferences and forums.



B. 365 Days Online Business-Matching

- **Social Media Interaction & Regular Updates**
Facebook, YouTube, LinkedIn, Instagram, Tiktok.
- **Online Business-Matching**
Assisting Buyers match with suitable suppliers.

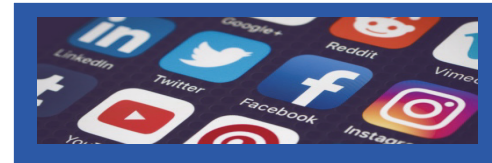

Overseas Buyers Offline
& Online Matching



C. VIP Program for Overseas Buyers

- **FREE Pass & Quick Entry**
Quick Entry into the hall, no more waste of time for getting in line.
- **Procurement Guidelines**
Brochure of brands and product exclusively for overseas buyers.
- **VIP Services**
 - ✓ Accommodation Recommendation list.
 - ✓ Discount flight tickets.
 - ✓ FREE vouchers.
 - ✓ FREE participation in activities.



D. VVIP Service

- **To Qualify for being VVIP:**
 - Purchase Exceeding USD 10 million;
 - Global Top 500 / local Top 100;
 - Over 3 multinational chains ;
 - A showroom with more than 1,000 sqm.
- **VVIP Privileges:**
 - ✓ Long-term CBD World-Connect VIP Card;
 - ✓ Express entry at all CBD events;
 - ✓ Welcome gift pack;
 - ✓ CBD VIP Lounge access;
 - ✓ Free matching services;
 - ✓ Shuttle bus services.

